

WOMEN'S HEALTH

HAYDEN MEDICAL



CLINIC

GYN Clinic • Colposcopy • LLETZ • Pessaries • Cryosurgery
Fertility • POP-Q Exam • Dopplers • Urogynecology
IUD Removal • Hysterosalpingography



SURGERY

Operating Room • Pelvic Surgery • Miyazaki Instruments • GYN Oncology
Laparoscopy • Urogynecology • Martin's Arm Retractor • Bariatric Surgery
Fiber-optic Retractors • Table Fixed Retractors
Liver Retractors

Version V

Call 661-296-7200 • www.haydenmedical.com • info@haydenmedical.com

Company Message

Hayden Medical is the source for high quality surgical instruments at reasonable prices. Why buy from the last supplier who charged your hospital, office or clinic a premium, when you can get your best deal right here with Hayden Medical. Save money today by purchasing from Hayden Medical for all of your stainless instrument, pessary, LLETZ, surgery instruments and endoscopy needs. We can also personalize your instruments with our laser marking system. With over 50 years of combined surgical instrument experience, we know how to make your budget dollars go further. We can also chase down your hard to find items and take the guesswork out of your day. High



Tom Ocasek Logistics Manager
Hayden Clelland VP Sales & Marketing
Scott Clelland Founder, CEO

quality instrumentation, great service and affordable pricing is our specialty. Please give us a try and see for yourself, firsthand, how helpful and cost effective we can be.

COMPANY MESSAGE

RETURNED GOODS POLICY

All returns must be accompanied by a Returned Goods Authorization number, available by calling our Customer Service Department.



The following information is needed to request authorization for a return.

- Reason for return
- Date of purchase
- Invoice or PO number
- Product number and size
- Quantity to return

All authorized returns must be made within thirty (30) days of the invoice date and accompanied by the appropriate purchase order number and Returned Goods Authorization number.

Allowable schedule for authorized return.

- Products processed in error by Hayden Medical, Inc. will be credited in full
- Defective product will be credited in full
- Unless defective or shipped in error, any return accepted is subject to up to a 25% restocking fee (minimum of \$10.00)

- All returned items are subject to Hayden Medical, Inc. inspection and acceptance
- Product must be shipped prepaid

Non-returnable, other than for manufacturing defect.

- Engraved instruments or instruments etched or labeled by the hospital
- Products damaged beyond repair or refurbishment or not in saleable condition
- Instruments returned more than thirty (30) days after invoice date
- Custom, laser marked, special or modified items
- Disposable items and Pessaries

Used products must be returned sterile wrapped or they will not be accepted.



Send all Returns to:

19425 Soledad Cyn. Road, #411
 Santa Clarita, CA 91351



TABLE OF CONTENTS

Colposcopy Instruments

Cervical Biopsy Punches	4
2mm Biopsy Forceps	5
Rotating Biopsy Forceps	6
Rainbow Biopsy Forceps	7
Rainbow Endocervical Curettes	7
Endocervical Curettes	8
Endometrial Samplers	8
Endometrial Curettes	8
Uterine Curettes	8
Endocervical Specula	9
Cervical Hooks	9
Cervical Tenacula	10
Uterine Forceps	10
IUD Instruments	11
Dressing & Tissue Forceps	12
Scissors	13
Needle Holders	13
Specula	14-16
Lateral Wall Retractors	16
Skin Biopsy Punch	17
Myoma Graspers	17
Ovum Forceps	17
Os Finders & Finder Sets	18
Dilators & Sounds	18
Cervical Dilators	19
Uterine Dilators	20

Urology

Urethral Dilators	20
Urethral Sounds	20-21
No-Scalpel Vasectomy Set	21
Circumcision Clamps	21

HSG Catheters

HSG Catheters	22
Sonography Catheters	22
HSG Procedure Kits	23
IUI Catheters	23

Urogynecology

Pessaries	24-25
Word Barthalon Cyst Catheters	26
Pessary Fitting Sets	26
Inflatable Pessary	26

Vaginal Dilator Sets	26
POP-Q Exam Stix	27

LLETZ / LEEPS Products & Accessories

LLETZ System	28
LLETZ Electrodes	19
ESU Accessories	30-31
Smoke Evacuator Accessories	30-31
Non-Conductive Specula	32-33
Non-Conductive Instruments	34

Laser Instruments

Non-Reflective Instruments	35
----------------------------	----

Obstetrics

Dopplers	36
----------	----

Examination Equipment

Colposcopes	37
-------------	----

Cryosurgery

Cryo Gun Systems	38
Cryo Tips	39

Office Hysteroscopy

Hysteroscopy Instruments	40
--------------------------	----

Light Sources

LED Light Sources	41
Doctor's Stool	41

Miyazaki Instruments

Miyazaki Retractors	42
Miyazaki Tack Driver	42
Hemorrhage Occluder Pins	42
Miyazaki Hook	42

Fiber-optic Retractors

Fiber-optic Retractors	43
Fiber-optic Light Cables	43

Pelvic Surgery Instruments

Z-Best Hysterectomy Clamps	40
Z-Best IFP Clamps	40
Z-Best Hysterectomy Scissors	41

Nolan Needle Holder	45
MD Anderson Clamp	46
Clark Clamps	46
Holds Fascia Harvester	46
Hulka Uterine Tenacula	47
Breisky Retractors	47
Weighted Specula	47

Martin's Arm Retractors

Martin's Arm Retractors	48
Martin's Arm Quick-Connect	49
Martin's Arm Accessories	49
Liver Retractors	49

Laparoscopy

Snake Retractors	50
Uterine Manipulators	51

Bariatric Instruments

14", 16" & 18" Long	52-53
---------------------	-------

Table Fixed Retractor & Accessories

Hayden-Trac Retractor System	54-55
Hayden-Trac Fixation & Rings	54
Hayden-Trac Retractor Blades	55
Hayden-Trac Sets	56-57

Laparoscopy

Lap Needle Holders	58
Hasson Graspers	59
Prestige Style Graspers	59
Fan Retractors	60
Knot Pushers	60
Lap Instrument Accessories	61
Lap Electrodes	61
Lap Fascia Closure Set	62
Sterilization Containers	62
Endoscopes	63
Laparoscopes	63
Hysteroscopes	63

BIOPSY FORCEPS

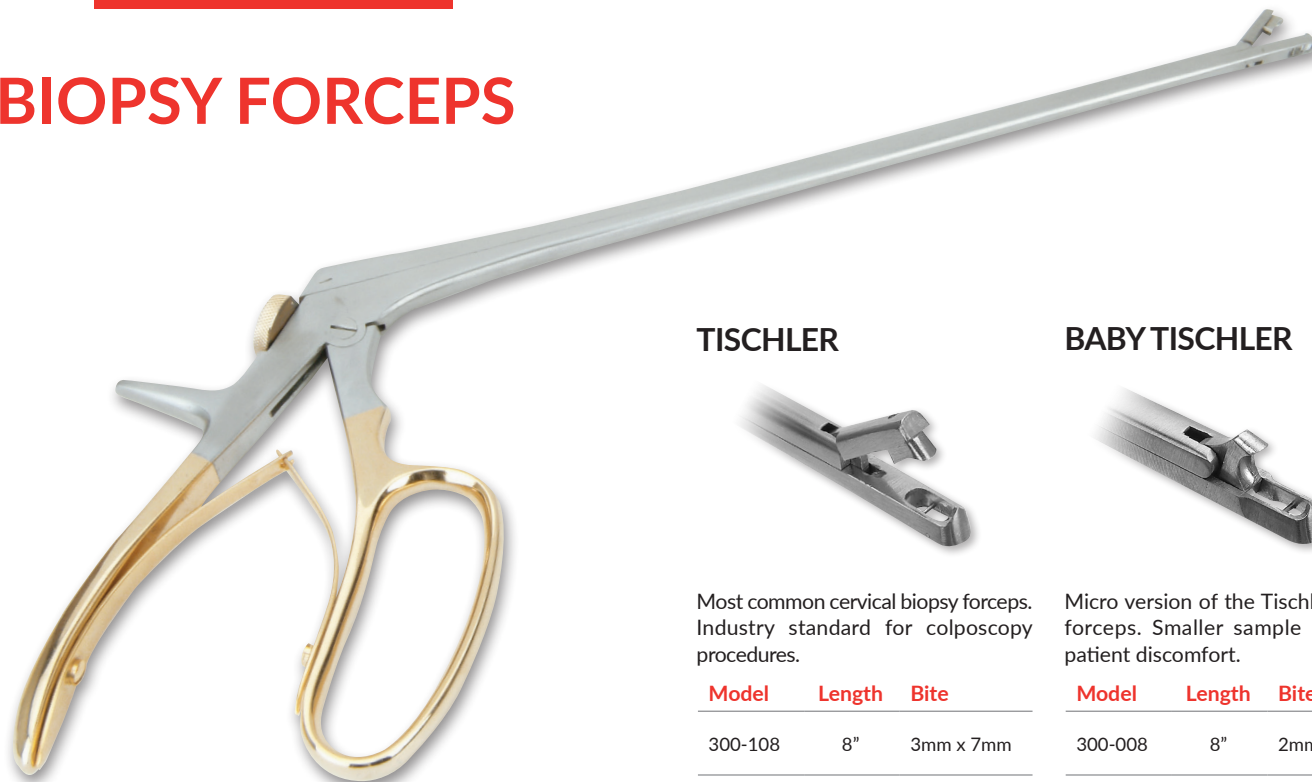

TISCHLER



Most common cervical biopsy forceps. Industry standard for colposcopy procedures.

Model	Length	Bite
300-108	8"	3mm x 7mm

★ 300-110 10" 3mm x 7mm

BABY TISCHLER



Micro version of the Tischler biopsy forceps. Smaller sample size, less patient discomfort.

Model	Length	Bite
300-008	8"	2mm x 4mm

★ 300-010 10" 2mm x 4mm

Hayden Medical Cervical Biopsy Forceps are made of high-quality German stainless steel to ensure a consistent sample biopsy. An integrated stop guard in the cutting part of the forceps prevents the sample from being crushed or damaged. Cervical biopsy forceps have gold handles and a locking handle to protect the cutting edges during sterile processing, transport and procedure setup. Micro or "Baby" patterns are available for a smaller, but still viable sample size.

KEVORKIAN

Similar to the Tischler biopsy forceps. Teeth on bottom jaw for grip.

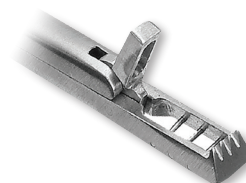

Model	Length	Bite
300-208	8"	3mm x 6mm
300-210	10"	3mm x 6mm

BURKE BIOPSY FORCEPS

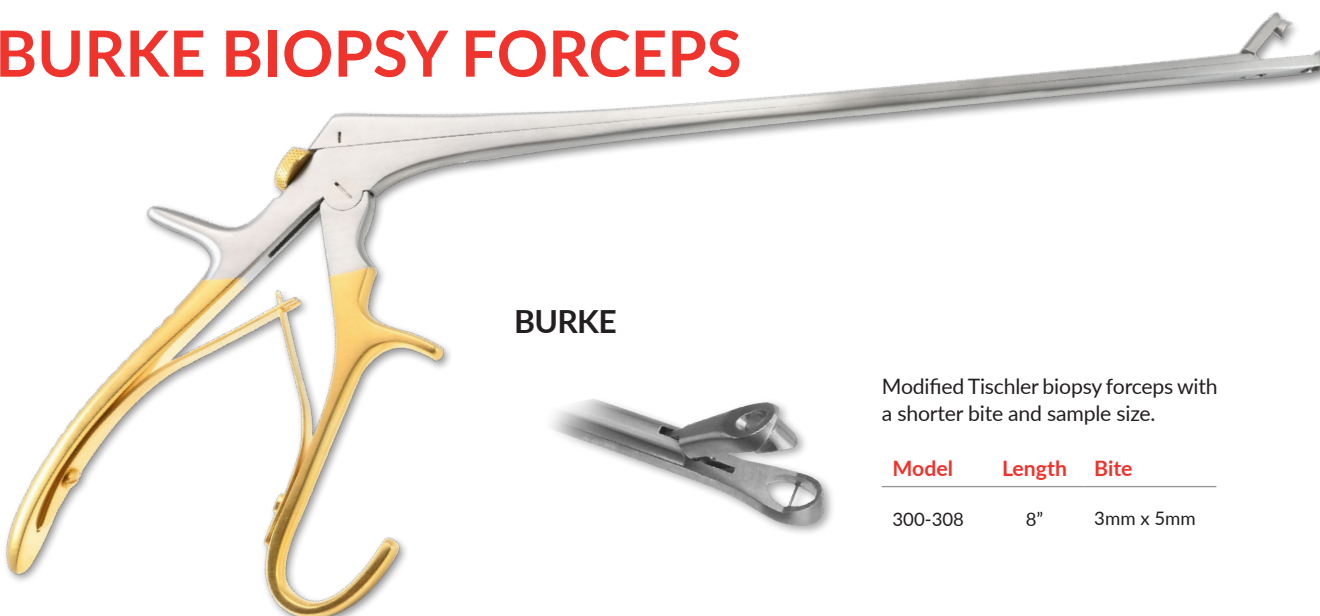

BURKE



Modified Tischler biopsy forceps with a shorter bite and sample size.

Model	Length	Bite
300-308	8"	3mm x 5mm

2 MM BIOPSY PUNCH

CUSTOM MARKING
 Ask about custom marking your instruments to help better identify the correct clinic, minimize loss and ultimately save money.

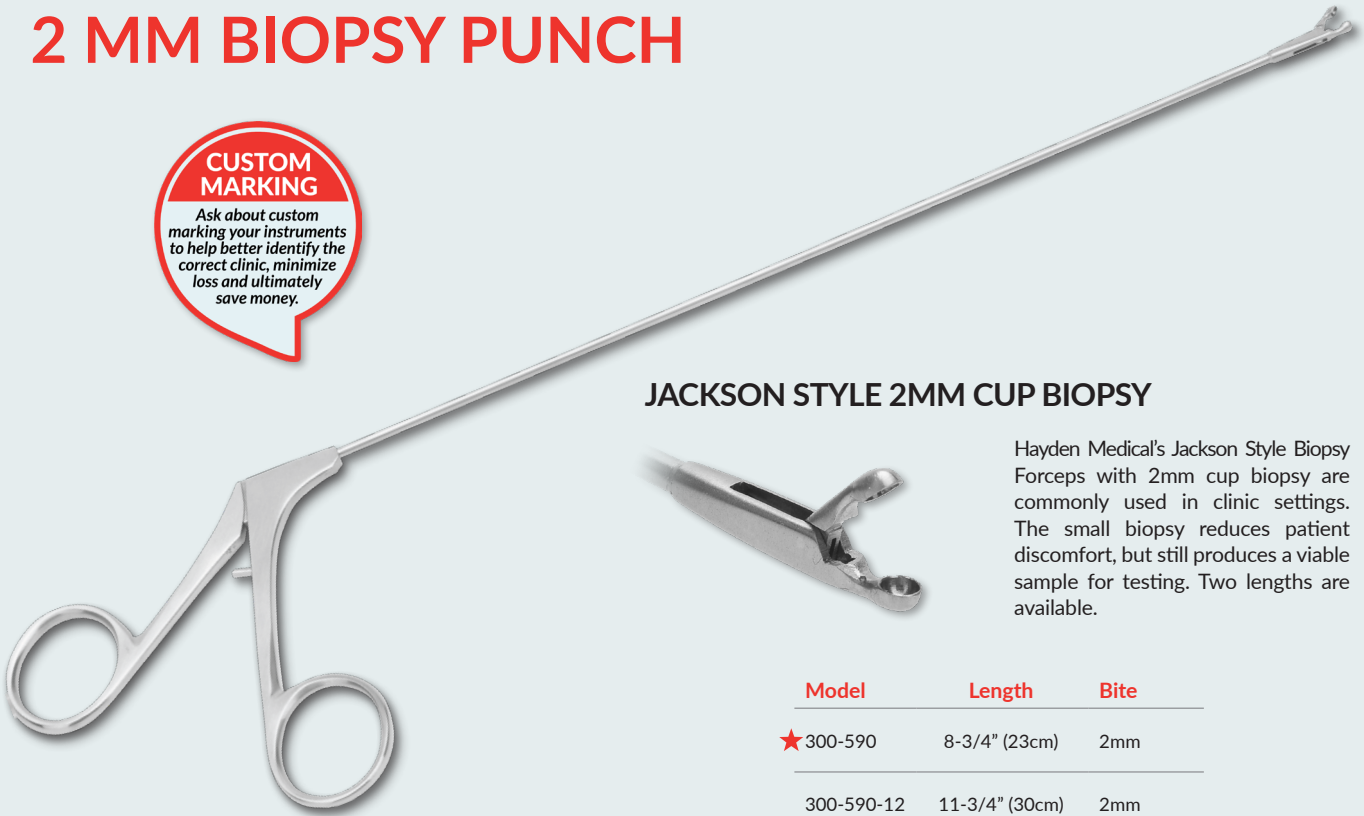

JACKSON STYLE 2MM CUP BIOPSY



Hayden Medical's Jackson Style Biopsy Forceps with 2mm cup biopsy are commonly used in clinic settings. The small biopsy reduces patient discomfort, but still produces a viable sample for testing. Two lengths are available.

Model	Length	Bite
★ 300-590	8-3/4" (23cm)	2mm
300-590-12	11-3/4" (30cm)	2mm

RING HANDLE BIOPSY FORCEPS

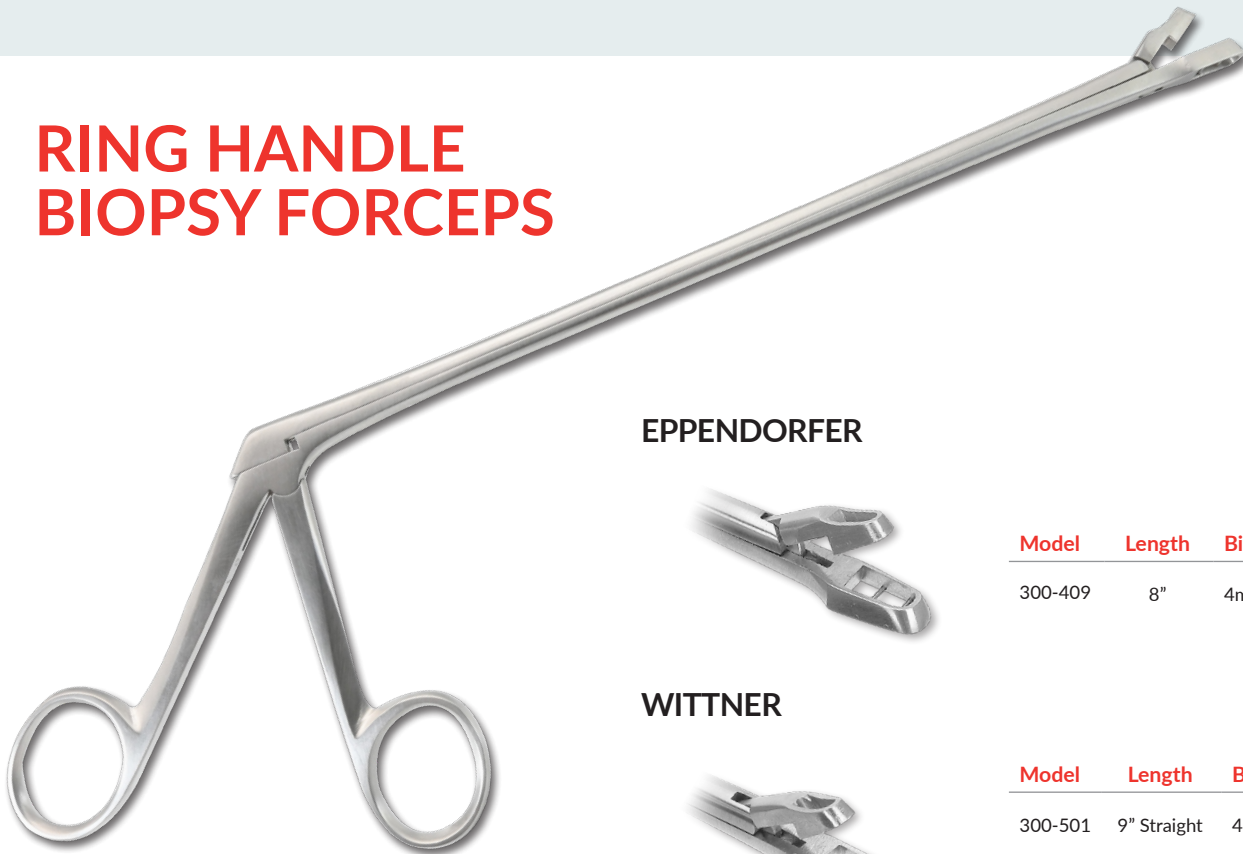

EPPENDORFER



Model	Length	Bite
300-409	8"	4mm x 8mm

WITTNER



Model	Length	Bite
300-501	9" Straight	4mm x 8mm
300-505	9" Angled	4mm x 8mm

CLINIC | BIOPSY FORCEPS

ROTATING CERVICAL BIOPSY PUNCHES

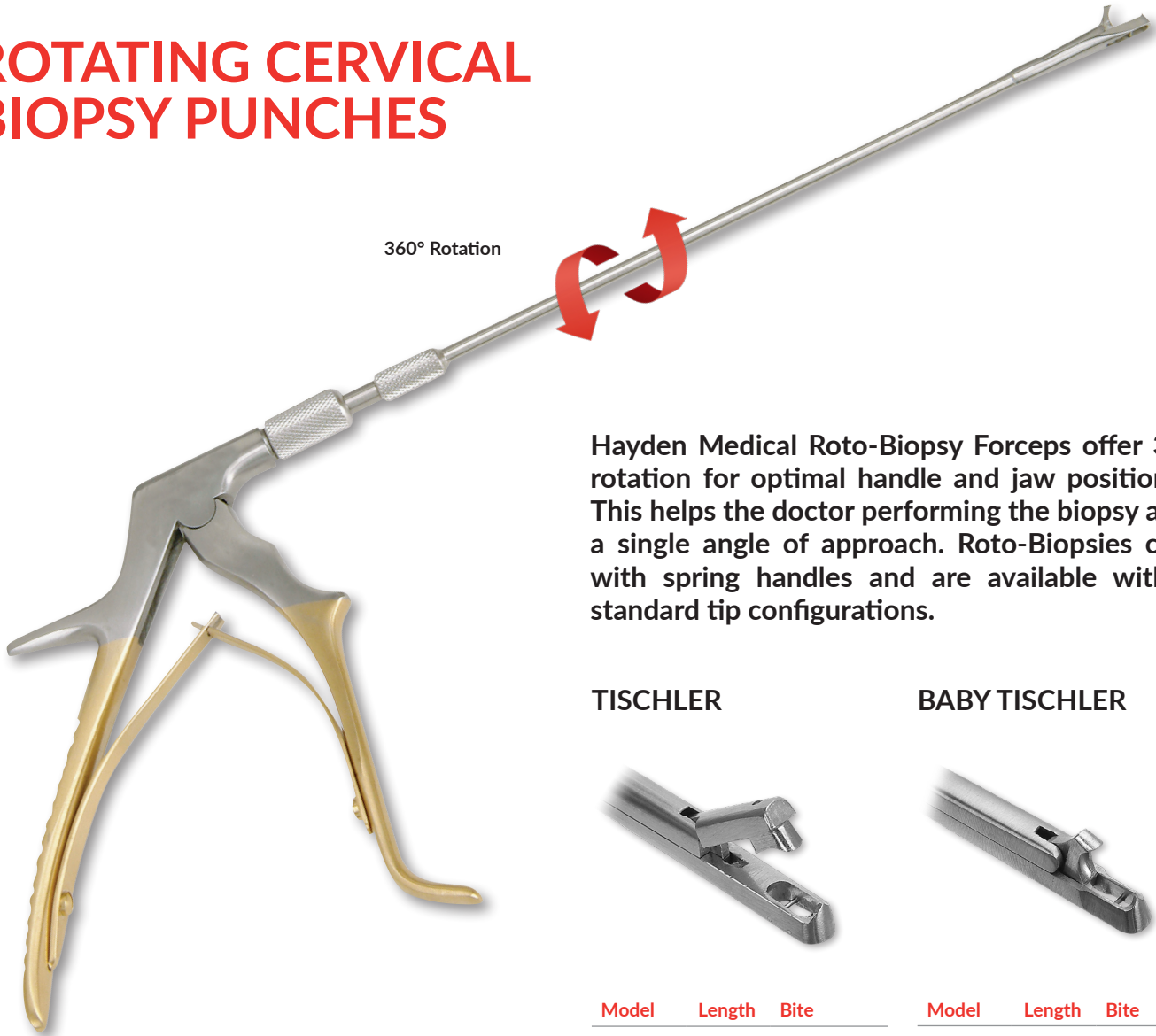

Hayden Medical Roto-Biopsy Forceps offer 360° rotation for optimal handle and jaw positioning. This helps the doctor performing the biopsy avoid a single angle of approach. Roto-Biopsies come with spring handles and are available with all standard tip configurations.

TISCHLER



BABY TISCHLER



Model	Length	Bite	Model	Length	Bite
★ 300-125	9"	3mm x 7mm	★ 300-025	9"	2mm x 4mm

BURKE



EPPENDORFER



KEVORKIAN

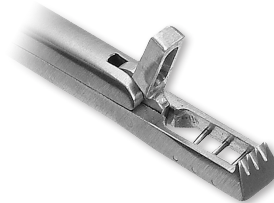

Model	Length	Bite	Model	Length	Bite	Model	Length	Bite
300-325	9"	3mm x 5mm	300-425	9"	4mm x 8mm	300-225	9"	3mm x 6mm

RAINBOW CERVICAL BIOPSY

Titanium Rainbow TiO coating on Hayden Rainbow Tischler Biopsy Forceps and Kevorkian curettes make these instruments harder than ordinary stainless steel. The cutting edges will stay sharper longer.

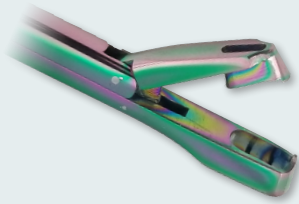

RAINBOW TISCHLER

Most common cervical biopsy forceps. Industry standard for colposcopy procedures.

Model	Length	Bite
300-108T	8"	3mm x 7mm

★ 300-110T 10" 3mm x 7mm

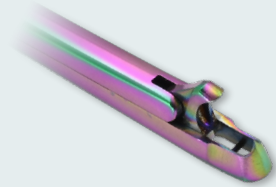

RAINBOW BABY TISCHLER

Micro version of the Tischler biopsy forceps. Smaller sample size, less patient discomfort.

Model	Length	Bite
300-008T	8"	2mm x 4mm

★ 300-010T 10" 2mm x 4mm

CLINIC | RAINBOW BIOPSY

RAINBOW KEVORKIAN ENDOCERVICAL CURETTES



WITH BASKET

Standard curette with basket to better retain samples upon removal.

Model	Description
295-401T	11-3/4", Rigid

WITHOUT BASKET

Standard endometrial curettage pattern.

Model	Description
295-402T	11-3/4", Rigid

KEVORKIAN ENDOCERVICAL CURETTES



WITH BASKET

WITHOUT BASKET

MINI



Standard curette with basket to better retain samples upon removal.

Standard pattern.

Micro version of our most popular curette for a smaller sample size.

Model	Description
★295-401	11-3/4", Rigid
295-403	11-3/4", Malleable

Model	Description
★295-402	11-3/4", Rigid
295-405	11-3/4", Malleable

Model	Description
295-404	11-3/4", Rigid

DISPOSABLE ENDOCERVICAL SAMPLERS

PREFERRED CURETTE

CURETTE WITH SYRINGE

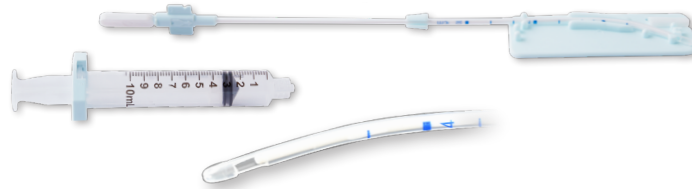

The Preferred Curette is used to obtain a sample of the mucosal lining for histological study in cancer screening, endometrial dating, or bacterial culturing.

This Randall-type cutting edge curette is packaged with a twist-and-lock syringe. Designed to obtain uterine samples of endometrial tissue for histological study.

Model	Description
★295-480	Preferred Curette 3.0mm Dia., Box/25

Model	Description
295-495	Curette with Syringe 3.0mm Dia., Box/25

ENDOMETRIAL & UTERINE CURETTES

NOVAK ENDOMETRIAL CURETTE

SIMS UTERINE CURETTE

Suction curette with teeth for sample collection.

Standard sharp uterine curette with multiple sizes. 11" malleable shaft.



Model	Description
295-451	1mm
★295-452	2mm
295-453	3mm
295-454	4mm



Model	Description	Model	Description
295-609	#00 (3mm)	295-613	#3 (11mm)
295-610	#0 (5mm)	295-614	#4 (13mm)
295-611	#1 (7mm)	295-615	#5 (15mm)
295-612	#2 (9mm)	295-616	#6 (17mm)

KOGAN ENDOCERVICAL SPECULA



WITH RATCHET

Ratchet allows for easy dilation of the cervical canal.

Model	Description
★ 295-502	3mm Narrow Tip, 10-3/4"
295-501	5mm Standard Tip, 10-3/4"



WITH SET SCREW

Set screw allows for precise dilation of the cervical canal.

Model	Description
295-512	3mm Narrow Tip, 10-3/4"
295-509	5mm Standard Tip, 10-3/4"



NON-LOCKING

Allows for immediate adjustment of specula.

Model	Description
295-504	3mm Narrow Tip, 10-3/4"
295-503	5mm Standard Tip, 10-3/4"

Endocervical specula are useful for viewing the distal endocervical canal. Long blades help to insert deeper into the cervix and retract more tissue for a better field of view, or to more easily visualize cervical polyps.



NARROW TIP

Useful in nulliparous or small women, post menopausal patients or those with a stenotic os. 3mm tip.



STANDARD TIP

Useful on multiparous women. 5mm tip.

CLINIC | ENDOCERVICAL SPECULA

CERVICAL HOOKS



IRIS



EMMETT



Model	Description	Model	Description	Model	Description	Model	Description
295-560	Small Curve, 9"	295-566	Half Curve, 9"	295-564	Right Angle, 9"	295-568	Double Angle, 9"

TENACULA



CUSTOM MARKING
Ask about custom marking your instruments to help better identify the correct clinic, minimize loss and ultimately save money.

BRAUN



Square ended forceps for cervical grasping and stabilization.

Model	Description
★325-070	Square Pincers

SCHROEDER



Round ended forceps for cervical grasping and stabilization.

Model	Description
★325-060	Rounded Pincers

POZZI-PALMER



Finer ended version of the round-tipped Schroeder Tenaculum.

Model	Description
325-055	Less Traumatic

ATRAUMATIC

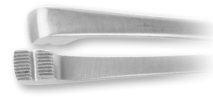

Designed to hold tissue without breaking the surface of the tissue.

Model	Description
325-075	Atraumatic

CERVICAL & UTERINE FORCEPS

FOERSTER SPONGE FORCEPS



Foerster sponge forceps have serrated oval tips and are used to hold a sponge or gauze during procedures. The long shaft length facilitates easier access to the cervix while the ratchet handles ensure a stable and firm grip on a sponge or gauze.

Model	Description
★140-600	9-1/2", Straight
140-610	9-1/2", Curved

BOZEMAN UTERINE FORCEPS



Bozeman Uterine Forceps have a double-curved shaft for better instrument tip visualization and a universal grasping jaw. Bozeman forceps can grasp gauze, sponges, manipulate tissue and be used as an extra-long hemostat.

Model	Description
140-620	10-1/4", Straight
★140-622	10-1/4", Double Curved

RANDALL FORCEPS

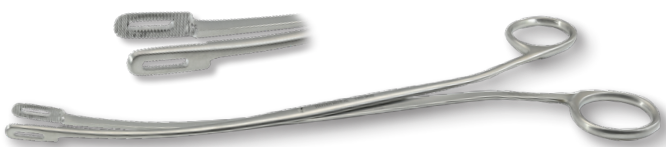

Used for grasping uterine polyps during curettage.

Model	Description
140-900	1/4 Curved, 9"

ALLIS TISSUE FORCEPS



Allis tissue forceps with 5x6 teeth ensure an atraumatic grip on tissue during colposcopy procedures. Ratchet handles keep a firm hold of tissue.

Model	Description
140-812	5x6 Teeth, 10"

IUD REMOVAL

SERPENTINE GRASPER



Malleable

Serpentine Grasper for IUD removal has a squeeze handle to open and close the teeth of the grasper. Malleable shaft facilitates a more versatile approach to IUD removal.

Model	Description
★295-800	8" Working Length, Malleable

NOYES GRASPER



Model	Description
200-142	6-1/2" Shaft, Serrated Jaws
★200-143	8" Shaft, Serrated Jaws
200-143-10	10" Shaft, Serrated Jaws

SIMPLE IUD HOOK

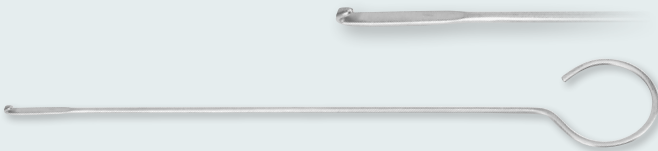

Model	Description
295-801	Simple IUD Hook, Malleable, 10"

DOUBLE IUD HOOK



Model	Description
295-805	Double IUD Hook, 10-1/4"

IUD ACCESSORY INSTRUMENTS

IUD STRING SCISSORS



Model	Description
★100-188F	9", Curved, Fine Tip
100-189	10", Curved

MAYO-HEGAR NEEDLE HOLDER



Model	Description
160-047	8"
160-048	9"

DRESSING & TISSUE FORCEPS

POTTS-SMITH DRESSING



Finer-tipped version dressing forceps with serrated jaws. Potts-Smith dressing forceps are used to grasp dressings, gauze, sponges and tissue.

Model	Description
120-156	8-1/4", Serrated
120-158	9-1/2", Serrated

POTTS-SMITH TISSUE

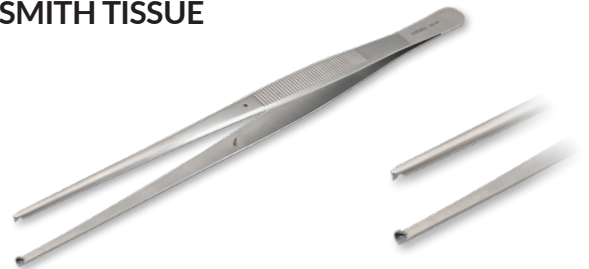

Finer-tipped version tissue forceps used for grasping and manipulating tissue. Can be used to stabilize tissue while suturing.

Model	Description
120-162	8-1/4", 1x2 Teeth
120-164	9-1/2", 1x2 Teeth

DRESSING



A common and versatile forceps with serrated jaws. Dressing forceps are used to grasp dressings, gauze, sponges and tissue.

Model	Description
120-014	8", Serrated
120-016	10", Serrated

TISSUE



A common forceps used for grasping and manipulating tissue. Can be used to stabilize tissue while suturing.

Model	Description
120-048	8", 1x2 Teeth
120-050	10", 1x2 Teeth

BONNEY

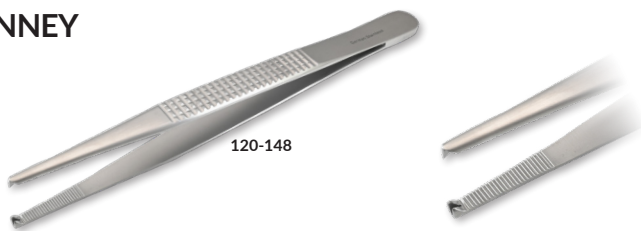

Model	Description
120-148	7", 1x2 Teeth & Serrated Tips
120-150	7", 2x3 Teeth & Serrated Tips
540-150	7", 1x2 Teeth & Serrated Tungsten Tips

ADSON DRESSING



The most common forceps for dressings and gauze. Usually referred to as thumb forceps with serrated tips.

Model	Description
120-117	4-3/4", Serrated

ADSON TISSUE

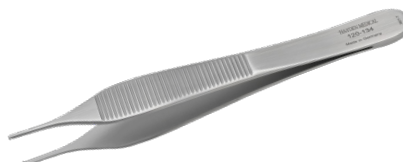

The most common forceps for tissue grasping. Usually referred to as thumb forceps or "rat tooth" forceps with 1x2 teeth.

Model	Description
120-134	4-3/4", 1x2 Teeth

ADSON-BROWN TISSUE



A common forceps for tissue grasping. These offer a longer gripping surface with 9x9 dual teeth along the tip of the instrument.

Model	Description
120-124	4-3/4", 9x9 Fine Teeth

CLINIC | FORCEPS

SCISSORS

MAYO



A thicker scissors used for cutting tissue, gauze and other materials. Mayo scissors with standard beveled blades are great all around utility scissors.

Model	Description
100-120	5-1/2", Straight
100-122	5-1/2", Curved
100-124	6-3/4", Straight
100-126	6-3/4", Curved
100-128	9", Straight
100-130	9", Curved

IRIS



Small scissors used for cutting suture. Sharp pointed tips allow the blades to cut suture of any size.

Model	Description
100-304	4-1/2", Straight
100-306	4-1/2", Curved

METZENBAUM



Fine round tips with a long and narrow shaft make the Metzenbaum scissors ideal for cutting IUD strings, suture and for performing other procedures that require a finer cutting blade.

Model	Description	Model	Description
100-179	5-1/2", Straight	100-183	8", Straight
100-180	5-1/2", Curved	100-184	8", Curved
100-181	7", Straight	100-186	9", Straight
100-182	7", Curved	100-188	9", Curved

OPERATING



Utility scissors offer many tip variations of sharp or blunt tipped blades. Straight versions listed below.

Model	Description	Model	Description
100-006	5-1/2", S/S	100-019	7-1/2", S/B
100-008	6-1/2", S/S	100-026	5-1/2", B/B
100-016	5-1/2", S/B	100-028	6-1/2", B/B
100-018	6-1/2", S/B		

NEEDLE HOLDERS

MAYO-HEGAR



Thick tipped needle driver for use with larger needles or sutures that require more force to pass through tissue.

Model	Description
160-044	6-1/4", Serrated
160-046	7", Serrated
160-047	8", Serrated
160-048	9", Serrated

CRILE-WOOD



Thin finer tipped needle holder for smaller sutures. Crile-Wood needle drivers have long and thin shanks.

Model	Description
160-050	6", Serrated
520-100	6", Serrated Tungsten Jaws
160-051	7", Serrated
520-118	7", Serrated Tungsten Jaws

HEANEY

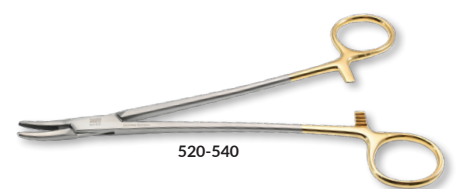

Needle driver with thick, curved tips allow the person suturing a different approach and angle to introducing a suture needle.

Model	Description
160-100	8-1/4", Curved Serrated Jaws
520-540	8-1/4", Curved Serrated Tungsten Jaws

STAINLESS STEEL SPECULA

Excellent Visibility
and Access

Designed for patient comfort, our wide variety of high quality specula meets your practice and patient exam needs. Also available in a non-conductive coating for electrosurgical LLETZ / LEEPS procedures (see pages 32-33) and a non-reflective coating for laser procedures (page 35).



**CUSTOM
MARKING**

Ask about custom marking your instruments to help better identify the correct clinic, minimize loss and ultimately save money.

STANDARD VIEW



MORE-VIEW



MAX-VIEW

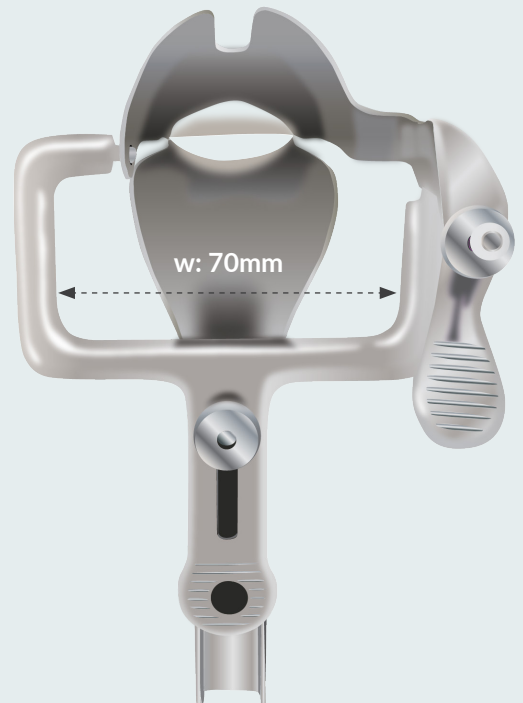

CLINIC | STAINLESS SPECULA

SPECULA

Hayden Medical offers a wide variety of specula for all of your office and O/R needs. Consider using our longer specula for your more obese patient population.

GRAVES



PEDERSON



MORE-VIEW



Model	Description	Size
315-301	Small	3" x 3/4"
★ 315-302	Medium	4" x 1-3/8"
★ 315-303	Large	4-3/4" x 1-1/2"
315-306	Moore-Graves	3-1/4" x 1-1/2"

Model	Description	Size
315-501	Virginal	3" x 1/2"
★ 315-502	Medium	4" x 1"
★ 315-503	Large	4-1/2" x 1"
315-504	X-Narrow	4" x 5/8"

Model	Description	Size
315-402	Graves, Small	3-1/2" x 1-1/2"
315-403	Graves, Medium	4" x 1-1/2"
315-404	Graves, Large	4-3/4" x 1-1/2"
315-413	Pederson, Medium	4" x 1"
315-414	Pederson, Large	4-1/2" x 1"

EXTRA-LONG



Hayden extra long specula Wide-View 4cm opening increases strength and visualization. Designed to fit the obese patient, the long blades safely provide cervical access.

Model	Description	Size
★ 315-602	Graves, X-Long	6" x 1-1/2"
★ 315-603	Pederson, X-Long	6" x 1"
315-605	Graves, XX-Long	7" x 1-1/2"

MAX-VIEW

The Max-View 7cm opening design significantly reduces the chance of obstructing the physicians view and instrument access.



Model	Description	Size
315-403XL	Graves, Medium	4" x 1-1/2"
315-404XL	Graves, Large	4-3/4" x 1-1/2"
315-406XL	Graves, X-Large	6" x 1-1/2"
315-413XL	Pederson, Medium	4" x 1"
315-414XL	Pederson, Large	4-1/2" x 1"

CLINIC | STAINLESS SPECULA

OPEN-SIDED SPECULA

WEISMAN (OPEN-SIDED) SPECULA



EXTRA-LONG WEISMAN (OPEN-SIDED) SPECULA



CLINIC | LATERAL RETRACTORS

Model	Description	Size
★ 315-104	Graves (Right Open), Medium	4" x 1-3/8"
★ 315-103	Graves (Right Open), Large	4-3/4" x 1-1/2"
315-104C	Graves (Right Open), Medium, 45°	4" x 1-3/8"
315-103C	Graves (Right Open), Large, 45°	4-3/4" x 1-1/2"
315-102	Graves (Left Open), Medium	4" x 1-3/8"
315-101	Graves (Left Open), Large	4-3/4" x 1-1/2"
315-111	Pederson (Right Open), Medium	4" x 1"

Model	Description	Size
★ 315-604	Graves (Right Open), X-Long	6" x 1-1/2"
315-608	Graves (Right Open), XX-Long	7" x 1-1/2"
315-606	Graves (Left Open), X-Long	6" x 1-1/2"
315-607	Graves (Left Open), XX-Long	7" x 1-1/2"
★ 315-609	Pederson (Right Open), X-Long	6" x 1"
315-609XL	Pederson (Right Open), XX-Long	7" x 1"

LATERAL WALL RETRACTION

4-WAY EXPANDER



This all-in-one speculum and lateral wall retractor increases visualization of the cervix by retracting redundant vaginal tissue. Especially effective for large of multiparous patients.

LATERAL WALL RETRACTORS

Hayden Lateral Wall Retractors fit inside the speculum to provide greater visibility and access to the cervix by retracting collapsed lateral walls.

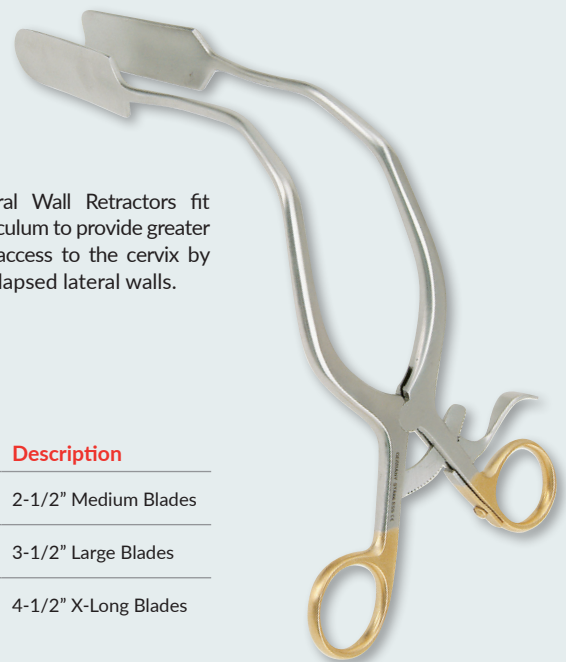

Model	Description	Size
315-320	Medium	3-1/4" x 7/8", with Tube Clip
315-321	Large	4" x 7/8", with Tube Clip
315-322	X-Large	5-1/4" x 1", with Tube Clip

Model	Description
315-610	2-1/2" Medium Blades
★ 315-612	3-1/2" Large Blades
315-614	4-1/2" X-Long Blades

MYOMA & OVUM FORCEPS

CORSON MYOMA GRASPER

For Atraumatic Transcervical Polyp And Myoma Removal.

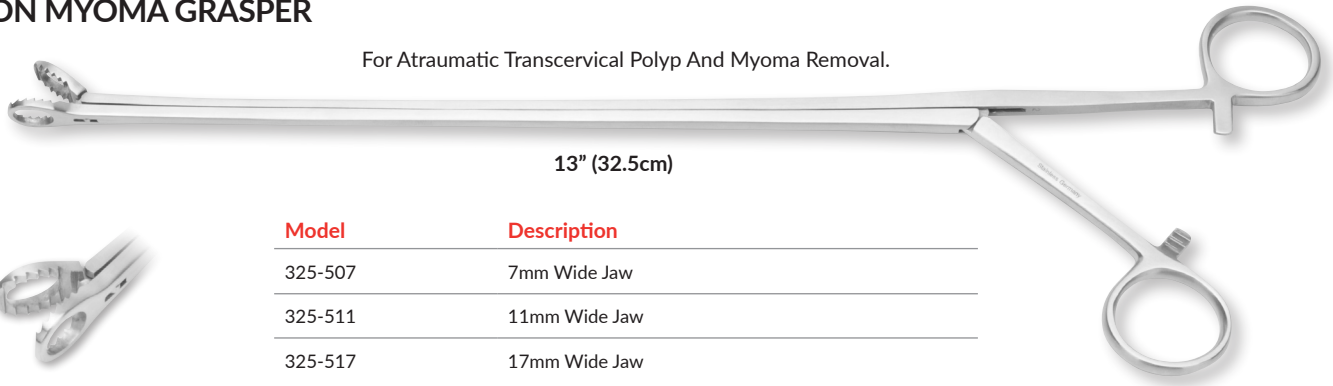

13" (32.5cm)

Model	Description
325-507	7mm Wide Jaw
325-511	11mm Wide Jaw
325-517	17mm Wide Jaw

SOPHER OVUM FORCEPS



11" (27.5cm)

Model	Description
325-212	12mm, without Ratchet
325-212R	12mm, with Ratchet
325-214	14mm, without Ratchet
325-214R	14mm, with Ratchet

BIERER OVUM FORCEPS



11" (27.5cm)

Model	Description
325-216	16mm, without Ratchet
325-216R	16mm, with Ratchet
325-219	19mm, without Ratchet
325-219R	19mm, with Ratchet

CLINIC | SKIN BIOPSY PUNCH

SKIN BIOPSY PUNCH

DISPOSABLE BIOPSY PUNCH



- Seamless blade
- Sharpened on both inside and outside
- Ergonomic, lightweight, ribbed handle for improved control
- Individually wrapped, ETO sterile
- Capped tip for added safety during handling and disposal
- Packaged in box of 50

Model	Size
033-040	1.5mm
033-041	2 mm
033-042	2.5mm
033-043	3mm
033-044	3.5mm
033-045	4mm
033-046	5mm
033-047	6mm
033-048	8mm

CERVICAL / UTERINE DILATORS

DISPOSABLE OS / CANAL DILATOR

- Ideal for use on post-menopausal patients with cervical stenosis
- 1.75mm tip gently dilates the stenotic os and canal
- Flexible to minimize perforation
- Disposable, individually sterile



Model	Description
★ 290-610	Canal Finder, Individually Sterile, Box / 50

CERVICAL OS DILATORS

ATRAUMATIC OS FINDER SET



- 1.75mm tip gently dilates the stenotic os and canal
- Flexible to minimize perforation
- Reusable, autoclavable
- Made of PTFE

Model	Description
★ 290-600	Set of 3 (Autoclavable)

KLEEGMAN DILATOR



Model	Description
290-003	1-3mm, at Tips, 10-3/4"

DILATOR SOUNDS

SIMS DILATOR SOUND



Model	Description
290-620	12-1/2", Malleable, Silver-plated, Graduated in cm's

DISPOSABLE UTERINE SOUND



Individually Sterile

Model	Description
★ 290-615	Uterine Sounds, Malleable, Disposable, Graduated in 3-11 cm's, Box of 25

CERVICAL / UTERINE DILATORS

DOUBLE ENDED HEGAR DILATORS

7-1/2" (19.1cm)



Model	Description	Model	Description
★ 290-100	Set of 8, (3-18mm)	290-113	13/14mm
290-101	1/2mm	290-115	15/16mm
290-103	3/4mm	290-117	17/18mm
290-105	5/6mm	290-119	19/20mm
290-107	7/8mm	290-121	21/22mm
290-109	9/10mm	290-123	23/24mm
290-111	11/12mm	290-125	25/26mm

*Larger sizes available upon request.

SINGLE ENDED HEGAR DILATORS

7" (17.5cm)



Model	Description	Model	Description
290-150	Set of 11, (1-6mm)	290-159	5.0mm
290-151	1.0mm	290-160	5.5mm
290-152	1.5mm	290-161	6.0mm
290-153	2.0mm	290-162	6.5mm
290-154	2.5mm	290-163	7.0mm
290-155	3.0mm	290-164	7.5mm
290-156	3.5mm	290-165	8.0mm
290-157	4.0mm	290-166	8.5mm
290-158	4.5mm	290-167	9.0mm

*Larger sizes available upon request.

HANK DILATORS

Double Ended, 11" (27.5cm)



Model	Description	Model	Description
★ 290-200	Set of 6, (9-20 Fr.)	290-217	17/18 Fr.
290-205	5/6 Fr.	290-219	19/20 Fr.
290-207	7/8 Fr.	290-221	21/22 Fr.
290-209	9/10 Fr.	290-223	23/24 Fr.
290-211	11/12 Fr.	290-225	25/26 Fr.
290-213	13/14 Fr.	290-227	27/28 Fr.
290-215	15/16 Fr.	290-229	29/30 Fr.

*Larger sizes available upon request.

PRATT DILATORS

Double Ended, 11-1/2" (28.8cm)



Model	Description	Model	Description
★ 290-300	Set of 8, (13-43 Fr.)	290-337	37/39 Fr.
290-313	13/15 Fr.	290-341	41/43 Fr.
290-317	17/19 Fr.	290-345	45/47 Fr.
290-321	21/23 Fr.	290-349	49/51 Fr.
290-325	25/27 Fr.	290-353	53/55 Fr.
290-329	29/31 Fr.	290-357	57/59 Fr.
290-333	33/35 Fr.	290-361	61/63 Fr.

*Larger sizes available upon request.

MINI CERVICAL DILATOR SET

- Versatile 1-3mm tips in 1/2 sizes
- Ideal for nulliparous patient
- Easy to use

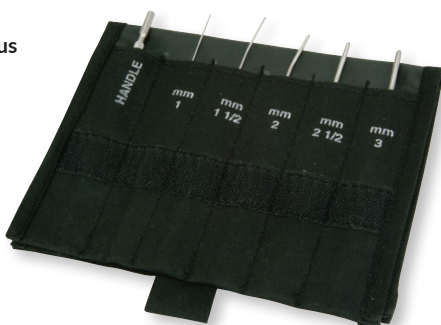

Model	Description
290-020	Mini Dilator Set

DENNISTON DILATOR SET



- 5/6mm to 13/14mm
- Double ended
- Autoclavable plastic

Model	Description
290-010	Denniston Dilator Set, 11-1/2"

CERVICAL / UTERINE DILATORS

HAWKIN-AMBLER UTERINE DILATORS



7-1/2" (18.8cm)

Model	Description	Model	Description
290-400	Set of 16, (3-6mm - 18-21mm)	290-411	11-14mm
290-403	3-6mm	290-412	12-15mm
290-404	4-7mm	290-413	13-16mm
290-405	5-8mm	290-414	14-17mm
290-406	6-9mm	290-415	15-18mm
290-407	7-10mm	290-416	16-19mm
290-408	8-11mm	290-417	17-20mm
290-409	9-12mm	290-418	18-21mm
290-410	10-13mm		

UROLOGY

WALTHER FEMALE DILATORS

This hollow dilator / catheter facilitates filling and emptying of the bladder.



5-1/2" (13.1cm)

MCCREA INFANT & FEMALE URETHRAL SOUNDS



7" (17.5cm)

Model	Description	Model	Description	Model	Description	Model	Description
★285-300	Set of 14, (12-38 Fr.)	285-324	24 Fr. (8.0mm)	285-199	Set of 15, (8-36 Fr.)	285-207	22 Fr. (7.3mm)
285-310	10 Fr. (3.3mm)	285-326	26 Fr. (8.6mm)	285-200	8 Fr. (2.6mm)	285-208	24 Fr. (8.0mm)
285-312	12 Fr. (4.0mm)	285-328	28 Fr. (9.2mm)	285-201	10 Fr. (3.3mm)	285-209	26 Fr. (8.6mm)
285-314	14 Fr. (4.6mm)	285-330	30 Fr. (10.0mm)	285-202	12 Fr. (4.0mm)	285-210	28 Fr. (9.2mm)
285-316	16 Fr. (5.3mm)	285-332	32 Fr. (10.6mm)	285-203	14 Fr. (4.6mm)	285-211	30 Fr. (10.0mm)
285-318	18 Fr. (6.0mm)	285-334	34 Fr. (11.2mm)	285-204	16 Fr. (5.3mm)	285-212	32 Fr. (10.6mm)
285-320	20 Fr. (6.6mm)	285-336	36 Fr. (12mm)	285-205	18 Fr. (6.0mm)	285-213	34 Fr. (11.2mm)
285-322	22 Fr. (7.3mm)	285-338	38 Fr. (12.7mm)	285-206	20 Fr. (6.6mm)	285-214	36 Fr. (11.9mm)

JEWETT URETHRAL SOUNDS

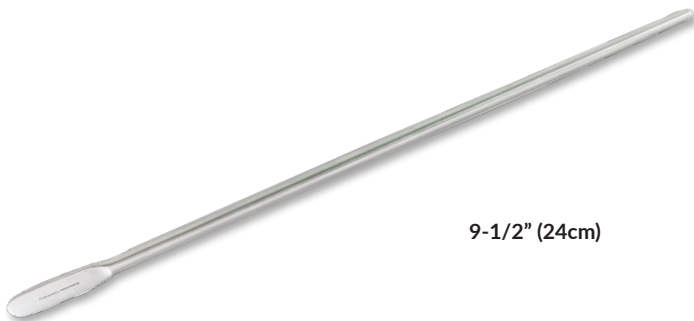

9-1/2" (24cm)

Model	Description	Model	Description
285-600	Set of 11, (12Fr. - 32Fr.)	285-608	22 Fr. (7.3mm)
285-603	12 Fr. (4.0mm)	285-609	24 Fr. (8.0mm)
285-604	14 Fr. (4.6mm)	285-610	26 Fr. (8.6mm)
285-605	16 Fr. (5.3mm)	285-611	28 Fr. (9.2mm)
285-606	18 Fr. (6.0mm)	285-612	30 Fr. (10.0mm)
285-607	20 Fr. (6.6mm)	285-613	32 Fr. (10.6mm)

UROLOGY

VAN BUREN URETHRAL SOUNDS

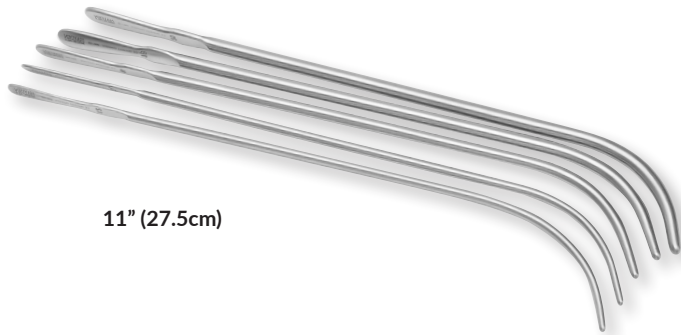

11" (27.5cm)

Model	Description	Model	Description
285-098	Set of 6, (14-24 Fr.)	285-108	24 Fr. (8.0mm)
285-099	Set of 12, (8-30 Fr.)	285-109	26 Fr. (8.6mm)
285-100	8 Fr. (2.6mm)	285-110	28 Fr. (9.2mm)
285-101	10 Fr. (3.3mm)	285-111	30 Fr. (10.0mm)
285-102	12 Fr. (4.0mm)	285-112	32 Fr. (10.6mm)
285-103	14 Fr. (4.6mm)	285-113	34 Fr. (11.2mm)
285-104	16 Fr. (5.3mm)	285-114	36 Fr. (11.9mm)
285-105	18 Fr. (6.0mm)	285-115	38 Fr. (12.5mm)
285-106	20 Fr. (6.6mm)	285-116	40 Fr. (13.2mm)
285-107	22 Fr. (7.3mm)		

DITTEL URETHRAL SOUNDS



11-1/2" (28.8cm)

Model	Description	Model	Description
285-500	Set of 14, (8-34 Fr.)	285-522	22 Fr. (7.3mm)
285-508	8 Fr. (2.6mm)	285-524	24 Fr. (8mm)
285-510	10 Fr. (3.3mm)	285-526	26 Fr. (8.6mm)
285-512	12 Fr. (4mm)	285-528	28 Fr. (9.2mm)
285-514	14 Fr. (4.6mm)	285-530	30 Fr. (9.9mm)
285-516	16 Fr. (5.3mm)	285-532	32 Fr. (10.6mm)
285-518	18 Fr. (6mm)	285-534	34 Fr. (11.2mm)
285-520	20 Fr. (6.6mm)		

NO-SCALPEL VASECTOMY SET



283-201

- No incision or stitches
- Faster procedure and recovery
- Less chance of hematomas and infections

Model	Description
★283-200	No-Scalpel Vasectomy Set (Ring & Dissector)
283-201	No-Scalpel Vasectomy Ring Clamp, 3.5mm ID, 5"
283-202	No-Scalpel Vasectomy Dissector, 5"



283-202

GOMCO CIRCUMCISION CLAMP



Model	Description
★382-111	Gomco Circumcision Clamp, Extra Small, 1.1cm
382-113	Gomco Circumcision Clamp, Newborn, 1.3cm
382-115	Gomco Circumcision Clamp, Child, 1.45cm

HSG & SHG CATHETERS

HSG SONO CATHETERS

Ideal for Hydrotubation, Salpingoplasty and Hysterosalpingography. HSG catheter sets can be used for sonohysterography and hysterosalpingography procedures that greatly enhance the analysis of uterine pathology. Using HSG balloon catheters, the procedures are simple and non-traumatic for your patients. A placement sheath eliminates the need for a tenaculum. HSG catheters are designed for single patient use only.

- Quick and easy to use
- Latex free product
- Low cost
- Sterile, disposable

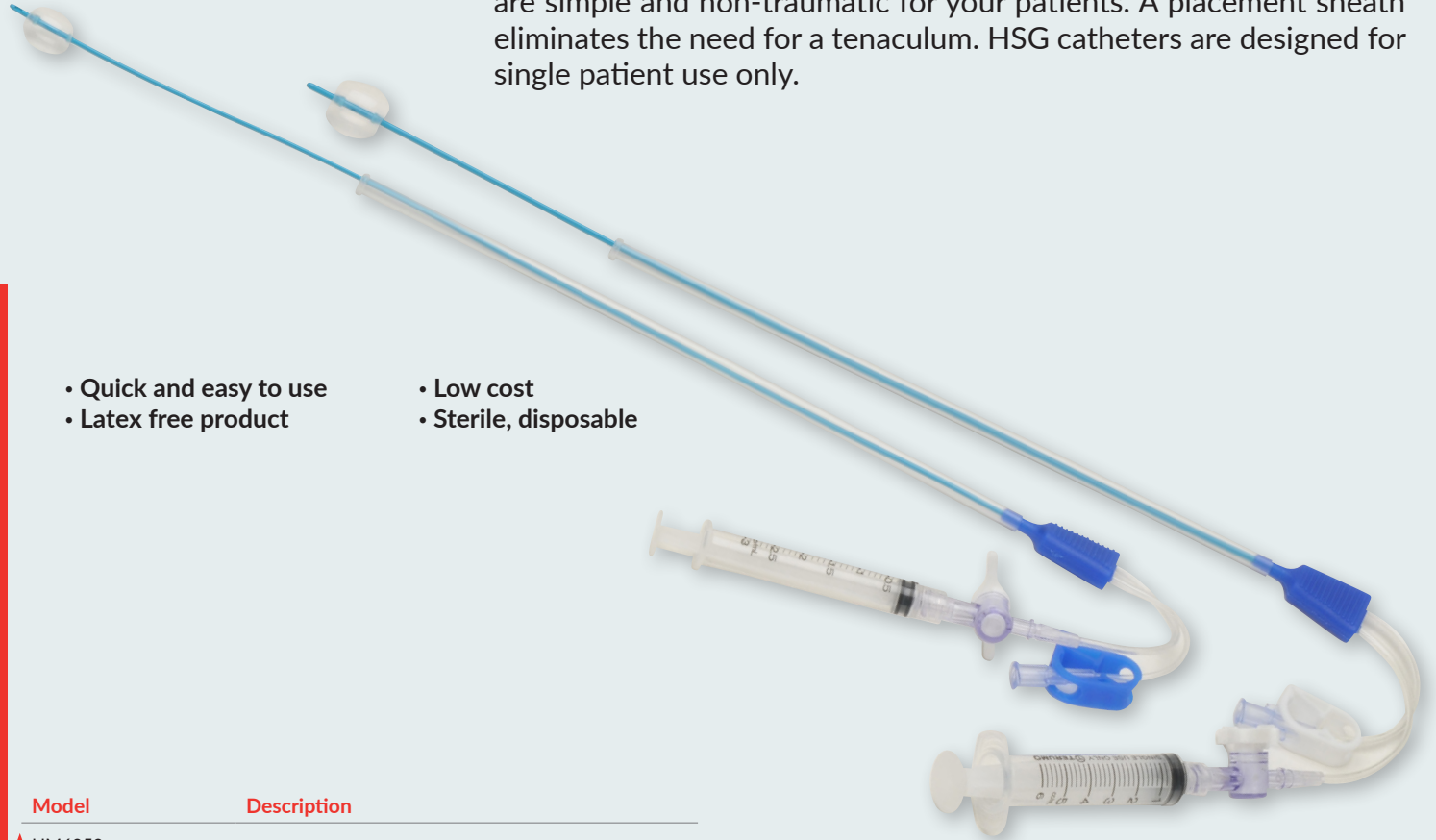

CLINIC | HSG

Model	Description
★HM6050	5 Fr., with 3cc Balloon & Syringe, Box of 10
HM6070	7 Fr., with 5cc Balloon & Syringe, Box of 10

DISPOSABLE UTERINE INJECTOR

- Quick and easy to use
- Non-latex balloons
- Low cost
- Sterile, disposable

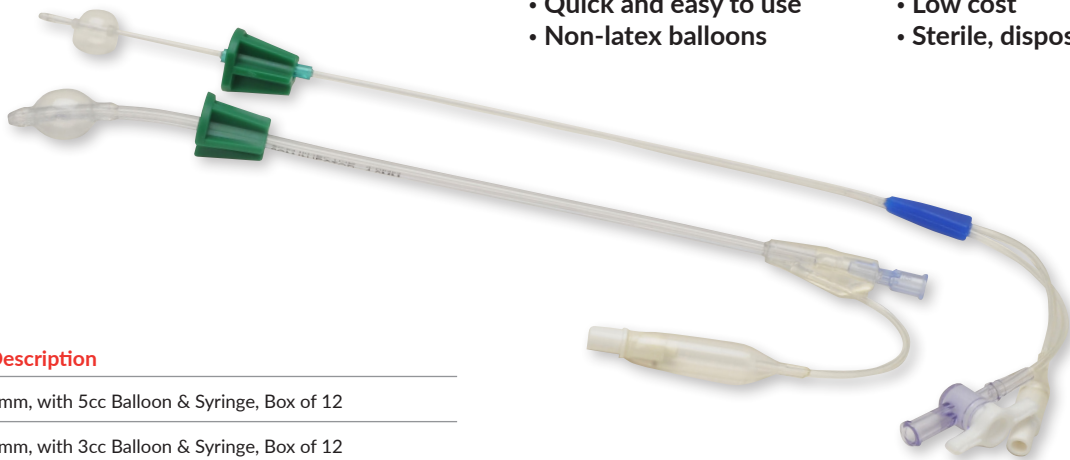

Model	Description
HM1152	4mm, with 5cc Balloon & Syringe, Box of 12
HM1153	2mm, with 3cc Balloon & Syringe, Box of 12

HSG PROCEDURE KIT

HSG PROCEDURE KIT

Ideal for various gynecologic procedures in the office setting, including Hydrotubation, Salpingoplasty and Hysterosalpingography. Disposable and very cost effective. All items are packaged in a sterile tray.



Tray Contents:

- (1) Vaginal speculum
- (3) Providone-iodine ointment
- (1) Surgical lubricant
- (2) Providone-iodine solution
- (1) Fenestrated drape
- (4) Gauze pads 4 x 4"
- (1) CSR wrap (30 x 30")
- (1) 20cc syringe
- (2) 8" Sponge swab
- (1) 20" Extension tube
- (1) Sanitary napkin
- (1) Cervical Os finder
- (1) Inner tray for providone-iodine solution
- (1) Intra-uterine sound

Model	Description
HM6080	HSG Procedure Set, Disposable, Individually Sterile, Box of 10

ROCKET® DUO™ IUI CATHETER

Rocket Medical DUO™ IUI Catheters are the latest generation of two part insemination catheters designed to improve ease of insertion and minimise uterine trauma

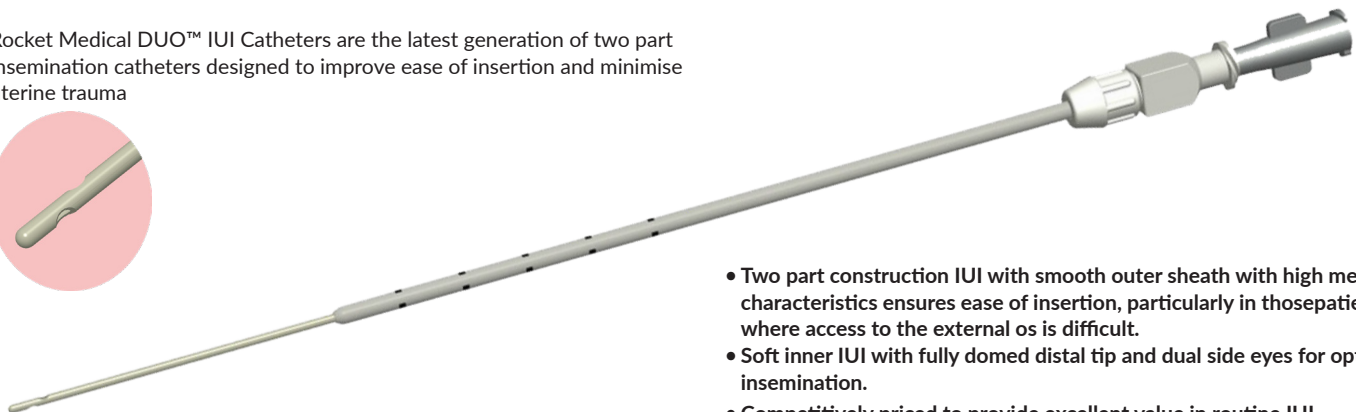
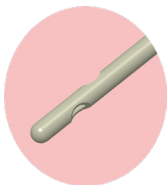

DUO™

Outer: HDPE, 5 x 1cm marking from distal tip.
Inner: Polyurethane OD: 1.4 mm, ID: 0.9 mm, fully domed, dual side eye.
Inner Catheter volume: 18cm: 0.5ml, 23cm: 0.63ml

- Two part construction IUI with smooth outer sheath with high memory characteristics ensures ease of insertion, particularly in those patients where access to the external os is difficult.
- Soft inner IUI with fully domed distal tip and dual side eyes for optimum insemination.
- Competitively priced to provide excellent value in routine IUI.
- Sterile for single use, packed in cartons of 25 units.

Model	Description
R57625	DUO™ IUI Catheter 18cm, Box of 25

SILICONE PESSARIES

Most Popular Sizes Shaded In Gray

RING

Available in ten sizes, both with and without support, this is a very common pessary for a first to second degree prolapse. The Ring with support can also be used on an accompanying cystocele. Insertion is eased with the folding action of the Ring.

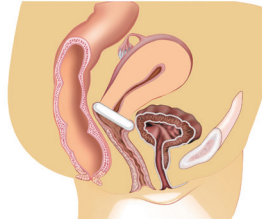

With Support		Without Support	
Model	Size	Model	Size
PR1.75S	#0	PR1.75	#0
PR2.00S	#1	PR2.00	#1
PR2.25S	#2	PR2.25	#2
PR2.50S	#3	PR2.50	#3
PR2.75S	#4	PR2.75	#4
PR3.00S	#5	PR3.00	#5
PR3.25S	#6	PR3.25	#6
PR3.50S	#7	PR3.50	#7
PR3.75S	#8	PR3.75	#8
PR4.00S	#9	PR4.00	#9

OVAL

Performs the same function as the Ring pessary but it is designed specifically to fit a narrow vaginal vault. It is available in nine sizes and is used for a first to second degree prolapse as well as an accompanying cystocele.

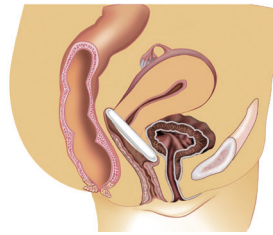

With Support		Without Support	
Model	Size	Model	Size
POV2.00S	#1	POV2.00	#1
POV2.25S	#2	POV2.25	#2
POV2.50S	#3	POV2.50	#3
POV2.75S	#4	POV2.75	#4
POV3.00S	#5	POV3.00	#5
POV3.25S	#6	POV3.25	#6
POV3.50S	#7	POV3.50	#7
POV3.75S	#8	POV3.75	#8
POV4.00S	#9	POV4.00	#9

SHAATZ

Available in nine sizes with drainage holes and used for a first to second degree prolapse and an accompanying cystocele.

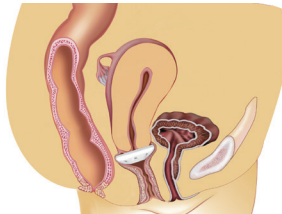

Model	Size	Model	Size
PSH1.50	#0	PSH2.75	#5
PSH1.75	#1	PSH3.00	#6
PSH2.00	#2	PSH3.25	#7
PSH2.25	#3	PSH3.50	#8
PSH2.50	#4		

GELLHORN

Used for a second to third degree prolapse, or procerdentia. It has drainage holes in its base and comes in ten sizes. The knob of the Gellhorn easily folds over for insertion, and once in place rests on the posterior vaginal wall.

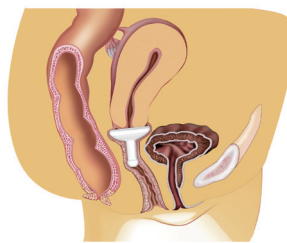

Regular Stem (1.5")		Short Stem (1.1")	
Model	Size	Model	Size
PG1.50D	#0	PGS1.50D	#0
PG1.75D	#1	PGS1.75D	#1
PG2.00D	#2	PGS2.00D	#2
PG2.25D	#3	PGS2.25D	#3
PG2.50D	#4	PGS2.50D	#4
PG2.75D	#5	PGS2.75D	#5
PG3.00D	#6	PGS3.00D	#6
PG3.25D	#7	PGS3.25D	#7
PG3.50D	#8	PGS3.50D	#8
PG3.75D	#9	PGS3.75D	#9

INCONTINENCE DISH

The Incontinence Dish is used to relieve stress incontinence and minor degree of prolapse. The Incontinence Dish comes with and without support. It is available in eight different sizes.

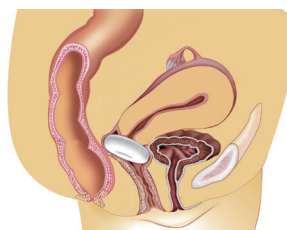

With Support		Without Support	
Model	Size	Model	Size
PDSH50S	#0	PDSH50	#0
PDSH55S	#1	PDSH55	#1
PDSH60S	#2	PDSH60	#2
PDSH65S	#3	PDSH65	#3
PDSH70S	#4	PDSH70	#4
PDSH75S	#5	PDSH75	#5
PDSH80S	#6	PDSH80	#6
PDSH85S	#7	PDSH85	#7

SILICONE PESSARIES

Most Popular Sizes Shaded In Gray

INCONTINENCE RING

Used for stress minor prolapse and incontinence. It is available both with and without support in ten different sizes.



Without Support			
Model	Size	Model	Size
PIR1.75	#0	PIR3.00	#5
PIR2.00	#1	PIR3.25	#6
PIR2.25	#2	PIR3.50	#7
PIR2.50	#3	PIR3.75	#8
PIR2.75	#4	PIR4.00	#9

HODGE

Has wires that allow it to be manually shaped for different anatomies. It can be used for a first to second degree prolapse, cystocele, stress incontinence and an incompetent cervix or uterine retroversion. It is available in ten sizes both with and without support.

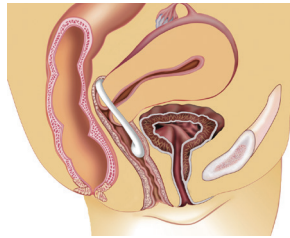

With Support		Without Support	
Model	Size	Model	Size
PHD65S	#0	PHD65	#0
PHD70S	#1	PHD70	#1
PHD75S	#2	PHD75	#2
PHD80S	#3	PHD80	#3
PHD85S	#4	PHD85	#4
PHD90S	#5	PHD90	#5
PHD95S	#6	PHD95	#6
PHD100S	#7	PHD100	#7
PHD105S	#8	PHD105	#8
PHD110S	#9	PHD110	#9

GEHRUNG

The Gehrung pessary has wires that allow it to be manually shaped for different anatomies. It is used to support both cystoceles and rectoceles as well as second to third degree uterine prolapse. It is available in ten sizes.

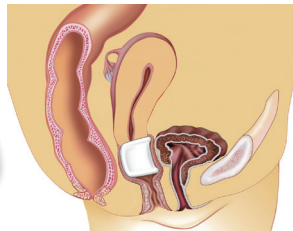

With Support			
Model	Size	Model	Size
PGH50S	#0	PGH75S	#5
PGH55S	#1	PGH80S	#6
PGH60S	#2	PGH85S	#7
PGH65S	#3	PGH90S	#8
PGH70S	#4	PGH95S	#9

DONUT

Designed for third degree prolapse as well as cystocele and rectocele. The soft donut can be compressed for insertion. It is available in eight sizes.

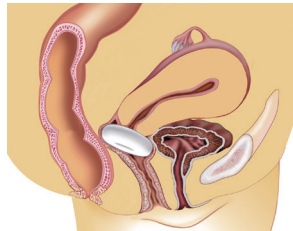

Model	Size	Model	Size
PD2.00	#0	PD3.00	#4
PD2.25	#1	PD3.25	#5
PD2.50	#2	PD3.50	#6
PD2.75	#3	PD3.75	#7

CUBE

Designed for third degree prolapse, including procedentia, as well as a cystocele and rectocele. The Cube pessary is available both with and without drainage holes and has a silicone tie to aid in removal. The Cube is available in eleven sizes.

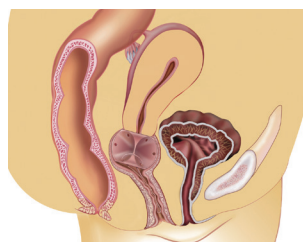

With Drain		Without Drain	
Model	Size	Model	Size
PCU25D	#0	PCU25	#0
PCU29D	#1	PCU29	#1
PCU33D	#2	PCU33	#2
PCU37D	#3	PCU37	#3
PCU41D	#4	PCU41	#4
PCU45D	#5	PCU45	#5
PCU50D	#6	PCU50	#6
PCU56D	#7	PCU56	#7
PCU63D	#8	PCU63	#8
PCU70D	#9	PCU70	#9
PCU75D	#10	PCU75	#10

SILICONE PRODUCTS

WORD BARTHOLIN CATHETER



This latex-free Bartholin Catheter Set contains a silicone inflatable catheter, scalpel, syringe, and needle, all needed in the treatment of Bartholin gland abscesses.

SILICONE INFLATABLE DONUT PESSARY



This pessary can be used to relieve the symptoms of a mild second or third degree cystocele or a rectocele in combination with proctodia/prolapse.

SILICONE PESSARY FITTING SET



Six of the most common sizes housed in a convenient Plexiglass case. Color coded in blue to indicate fitting set pessaries. Sizes #2-7.

Model	Description
HWC400	Box of 6, Individually Sterile

Model	Description
PID2.00	#2
PID2.25	#3
PID2.50	#4
PID2.75	#5

Model	Description
PF1000	Ring without Support
PF2000	Cube without Drain
PF3000	Dish without Support
PF4000	Oval without Support
PF5000	Gellhorn without Support

SILICONE VAGINAL DILATOR SETS

Each reusable set includes four graduated sizes of dilators used to enlarge the vagina for examination, surgical procedure, or relief of vaginismus.

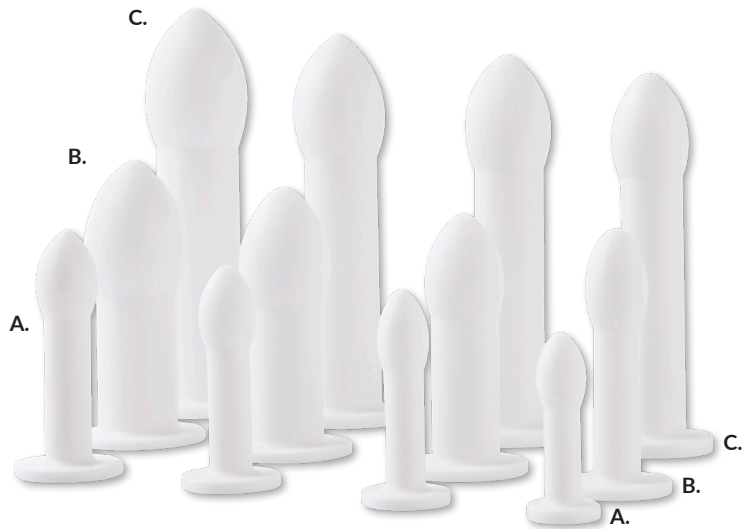

VAGINAL-PEDIATRIC

Model	Description	
PDS-A	Small Set of Four	
Length	OD Small	OD Large
75.0mm	13.5mm	18.0mm
65.0mm	12.0mm	16.0mm
60.0mm	10.5mm	14.0mm
50.0mm	9.5mm	13.0mm

VAGINAL-RECTAL

Model	Description	
PDS-B	Medium Set of Four	
Length	OD Small	OD Large
95.0mm	26.0mm	33.0mm
86.0mm	22.5mm	28.0mm
78.0mm	19.5mm	23.0mm
75.0mm	12.5mm	17.0mm

VAGINAL-HYMENAL

Model	Description	
PDS-C	Large Set of Four	
Length	OD Small	OD Large
150.0mm	30.0mm	38.0mm
138.0mm	25.5mm	22.0mm
128.0mm	22.5mm	28.0mm
120.0mm	19.5mm	24.0mm

POP-Q EXAM STICKS

The pelvic organ prolapse quantification (POP-Q) exam is used to quantify, describe, and stage pelvic support.

- There are 6 points measured at the vagina with respect to the hymen
- Points above the hymen are negative numbers; points below the hymen are positive numbers
- All measurements except tvl are measured at maximum valsalva

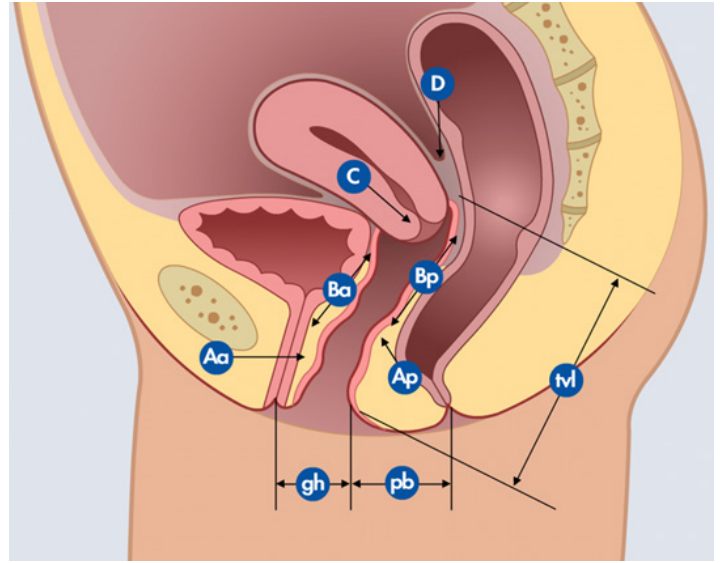

Model	Description
★ 222-222	Pop-Q Sticks, Bag of 50

Point	Description	Range of Values
Aa	Anterior vaginal wall 3 cm proximal to the hymen	-3 cm to +3 cm
Ba	Most distal position of the remaining upper anterior vaginal wall	-3 cm to +tvl
C	Most distal edge of cervix or vaginal cuff scar	
D	Posterior fornix (N/A if post-hysterectomy)	
Ap	Posterior vaginal wall 3 cm proximal to the hymen	-3 cm to +3 cm
Bp	Most distal position of the remaining upper posterior vaginal wall	-3 cm to +tvl

Genital hiatus (gh) – Measured from middle of external urethral meatus to posterior midline hymen
Perineal body (pb) – Measured from posterior margin of gh to middle of anal opening
Total vaginal length (tvl) – Depth of vagina when point D or C is reduced to normal position

POP-Q Staging Criteria	Description
Stage 0	Aa, Ap, Ba, Bp = -3 cm and C or D ≤ - (tvl - 2) cm
Stage I	Stage 0 criteria not met and leading edge < -1 cm
Stage II	Leading edge ≥ -1 cm but ≤ +1 cm
Stage III	Leading edge > +1 cm but < + (tvl - 2) cm
Stage IV	Leading edge ≥ + (tvl - 2) cm

REFERENCE: Bump RC, Mattiasson A, Bo K, et al. The standardization of terminology of female pelvic organ prolapse and pelvic floor dysfunction. Am J Obstet Gynecol. 1996;175:13.

LLETZ / LEEPS ELECTROSURGICAL UNIT AND SMOKE EVACUATOR

We've combined our ESU package with our superb smoke evacuation system and our latest mobile stand technology to produce a compact, mobile system for the clinic or hospital. As an added benefit, we included a loop electrode kit (5 of our most popular loops) and ten smoke evacuator tubing sets for attaching a vaginal speculum to create the best GYN system on the market today.

ELECTROSURGICAL UNIT

The Hayden ESU (LA1250S) is the affordable solution for the busy physician office or specialty facility. The multi-purpose unit features a modern push button design and is capable of most monopolar and bipolar surgical procedures. The Hayden ESU offers 5 energy outputs with up to 120 watts of power; modalities include Cut, Blend, Coagulation, Fulguration and Standard Bipolar. The unit is designed with dependable safety features like BovieNEM™ (Neutral Electrode Monitoring) pad sensing technology, BovieDED™ (Digital Error Detection), audible alert tones and self-test circuits. The Hayden ESU satisfies the physician's electrosurgical needs with safety, reliability and convenience.

SMOKE EVACUATOR

A modern, light-weight, compact design allowing for simplified use, storage and stack-ability. The Extended-Life Filter (LA6079) offers up to 35 hours of performance reducing procedure cost by ~38% from the previous model, when used at the lowest setting. Covered 3-port filter design accommodates a variety of tubing sizes [1/4"(6.4mm), 3/8"(9.5mm), and 7/8"(22mm)] providing versatility in procedure and accessory setup. The ultra-quiet design offers the same excellent performance with less noise.

MOBILE STAND

18.9" (483mm) Wide x 19.6" (500mm) Deep x 32" (814mm) High



Model	Description
LA1250G	Hayden LLETZ/LEEPS System (includes below)
LA1250S	Electrosurgical Generator (100-240 VAC)
LA6004	Smoke Shark System (110v)
LA6079	35-Hour Filter, included as part of LA6004
LA6074	Smoke Tube, 7/8" Tube, 6' Long, Box of 10
LA814-C	Mobile Stand

International Option:

Model	Description
LA6004-220	Smoke Shark System (220-240v), includes 35-Hour Filter

Mode	Output Power
Cut	120 watts
Blend	90 watts, (60% Cut, 40% Coag)
Coagulation	80 watts
Fulguration	40 watts
Bipolar	30 watts

LLETZ ELECTROSURGICAL ELECTRODES AND ACCESSORIES

LLETZ ELECTROSURGICAL ELECTRODES

Individually sterile for single use.



- Quality tungsten loop wire
- Standard 3/32" hand pencil connection
- Packaged single sterile, box of 5

RADIUS LOOP ELECTRODE



BALL ELECTRODE



SQUARE LOOP ELECTRODE



Model	Description
LL1005	Radius 10mm x 5mm Loop
LL1010	Radius 10mm x 10mm Loop
LL1507	Radius 15mm x 7mm Loop
LL1510	Radius 15mm x 10mm Loop
LL1512	Radius 15mm x 12mm Loop
LL1515	Radius 15mm x 15mm Loop
LL2008	Radius 20mm x 8mm Loop
LL2010	Radius 20mm x 10mm Loop
LL2012	Radius 20mm x 12mm Loop
LL2015	Radius 20mm x 15mm Loop
LL2020	Radius 20mm x 20mm Loop
LL2510	Radius 25mm x 10mm Loop

Model	Description
LL003B	3mm Ball
LL005B	5mm Ball

Model	Description
LL1004S	10mm x 4mm Square Loop
LL1008S	10mm x 8mm Square Loop
LL1010S	10mm x 10mm Square Loop

ELECTROSURGICAL ELECTRODE TIP CLEANER WITH RADIOPAQUE STRIP

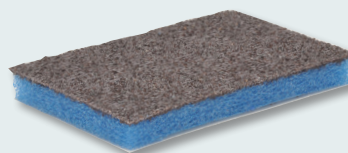

Model	Description
LA6175	Box of 40, Individually Sterile

CLINIC | LLETZ ELECTRODES

HAYDEN ESU AND SMOKE ACCESSORIES

DISPOSABLE HAND PENCIL



Model	Description
LA6041	6" Hand Control with Attached 10' Cord and Valley Lab (3-Prong) Connector, Sterile Disposable, Box of 25

REUSABLE HAND PENCIL



Model	Description
LA6042	6" Hand Controlled with Attached 10' Cord and Valley Lab (3-Prong) Connector, Autoclavable / Reusable, Each

SMOKE SHARK ULPA LONG LIFE FILTER



Model	Description
LA6079	35 Hour, Covered 3-Port, Each

SMOKE EVAC TUBING SET

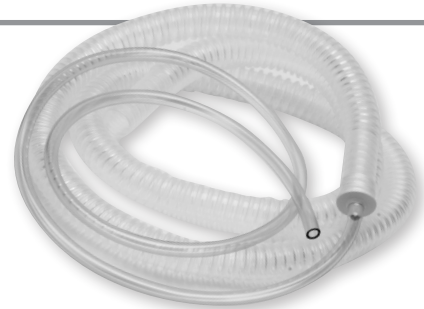

Model	Description
LA6074	6' x 7/8" Corrugated Tubing with Reducer Fitting and 2' x 1/4" Silastic Medical Tubing, Non-Sterile, Case of 10

DUAL DISPERSIVE GROUNDING PADS



Model	Description
LA6048	10' Cord, Individually Sterile, Box of 25

MONSEL'S SOLUTION (Ferric Subsulfate)



Model	Description
WS909084	Single Dose (8ml), Box of 12

DENTAL SYRINGE



Model	Description
030-001	Astra Type Aspirating, Holds Cartridge, 1.8cc, Inch Thread

ELECTROSURGICAL UNIT ADAPTERS



Model	Description	Model	Description	Model	Description
LA6010	Hand Piece Adapter	LA6051	Patient Pad Adapter	LA6052	Patient Pad Adapter

CLINIC | LLETZ ACCESSORIES

LLETZ / LEEP ACCESSORIES

FOOT CONTROLLED PENCIL

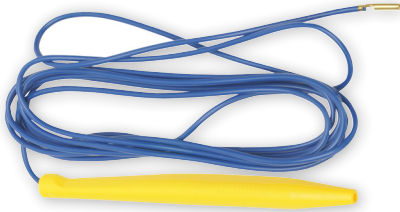

Model	Description
LA6040	6" Foot Controlled with Attached 10' Cord, Individually Sterile, Box of 25

SMOKE EVACUATION TUBING SET



Model	Description
LA6084	8' x 3/8" Medical Tubing with 9" x 1/4" DSE Straw, Individually Sterile, Box of 10

DISPOSABLE SMOKE EVACUATOR (DSE) TUBING



Model	Description
LA6150	9" x 1/4"OD x 3/16"ID, Non-Sterile, Bag of 50

PATIENT RETURN ELECTRODE PADS



Model	Description
LA6050	10' Cord, Individually Sterile, Box of 25

PATIENT RETURN ELECTRODE PADS



Model	Description
LA6049	10' Cord, without Cable, Individually Sterile, Box of 25

ULPA CHARCOAL FILTER



Model	Description
LA6082	6-1/4" Dia. x 12-1/4" L, Each

MINI-VAC ULPA CHARCOAL FILTER



Model	Description
LA6072	3" Dia. x 6" L, Each
LA6072-3	3" Dia. x 6" L, Case of 3

SMOKE SHARK ULPA LONG LIFE FILTER



Model	Description
LA6078	18 hour, Each

PRE-FILTER "TOP-HAT" FOR SMOKE FILTER



Model	Description
LA6081	6-1/4" x 1-1/3" Opening, Box of 10

SMOKE TUBING REDUCER / CONNECTORS

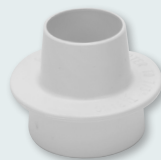

Model	Description
LA6083L-10	Top-Hat to Corrugated Tubing 1-1/3" to 7/8", Bag of 10

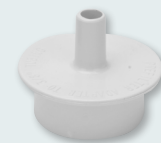

Model	Description
LA6083-10	Top-Hat to Clear Tubing 1-1/3" to 3/8", Bag of 10

NON-CONDUCTIVE SPECULA

Hayden non-conductive instruments are compatible with any LLETZ or LEEPS system.
Reliable and autoclavable.

STANDARD



WEISMAN (OPEN-SIDED)



CLINIC | LLETZ SPECULA

Model	Description	Size
L315-301	Graves, Small	3" x 3/4"
★ L315-302	Graves, Medium	4" x 1-1/2"
★ L315-303	Graves, Large	4-3/4" x 1-1/2"
L315-501	Pederson, Virginal	3" x 1/2"
L315-502	Pederson, Medium	4" x 1"
L315-503	Pederson, Large	4-1/2" x 1"
L315-504	Pederson, X-Narrow	4" x 5/8"

Model	Description	Size
★ L315-104	Graves (Right Open), Medium	4" x 1-1/2"
★ L315-103	Graves (Right Open), Large	4-3/4" x 1-1/2"
L315-102	Graves (Left Open), Medium	4" x 1-1/2"
L315-101	Graves (Left Open), Large	4-3/4" x 1-1/2"
L315-111	Pederson (Right Open), Medium	4" x 1"

EXTRA-LONG



Hayden Extra-Long specula with More-View 4cm opening increases strength and visualization. Designed to fit obese patients, the long blades safely provide cervical access.

EXTRA-LONG WEISMAN (OPEN-SIDED)



Model	Description	Size
L315-602	Graves, X-Long	6" x 1-1/2"
L315-605	Graves, XX-Long	7" x 1-1/2"
L315-603	Pederson, X-Long	6" x 1"
L315-603XL	Pederson, XX-Long	7" x 1"

Model	Description	Size
L315-604	Graves (Right Open), X-Long	6" x 1-1/2"
L315-608	Graves (Right Open), XX-Long	7" x 1-1/2"
L315-606	Graves (Left Open), X-Long	6" x 1-1/2"
L315-607	Graves (Left Open), XX-Long	7" x 1-1/2"
L315-609	Pederson (Right Open), X-Long	6" x 1"
L315-609XL	Pederson (Right Open), XX-Long	7" x 1"

NON-CONDUCTIVE SPECULA

MORE-VIEW

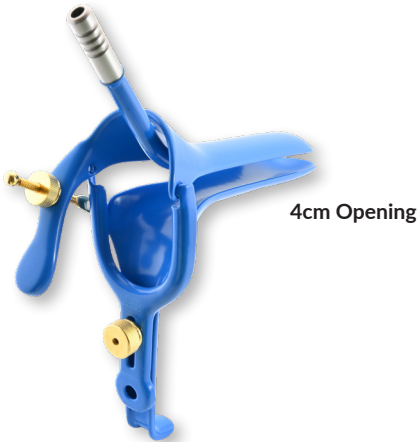

MAX-VIEW

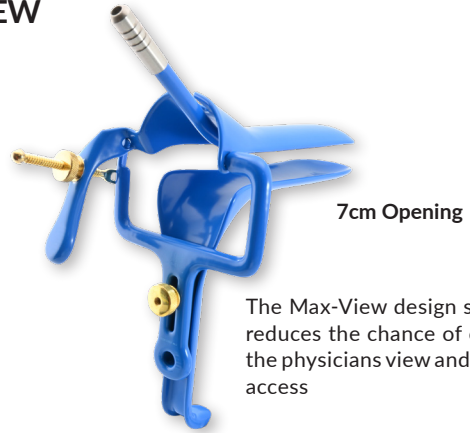

Model	Description	Size
L315-401	Graves, Medium	4" x 1-1/2"
L315-402	Graves, Large	4-3/4" x 1-1/2"

Model	Description	Size
L315-401XL	Graves, Medium	4" x 1-1/2"
L315-402XL	Graves, Large	4-3/4" x 1-1/2"
L315-406XL	Graves, X-Large	6" x 1-1/2"
L315-413XL	Pederson, Medium	4" x 1"
L315-414XL	Pederson, Large	4-1/2" x 1"

4-WAY EXPANDER SPECULUM & LATERAL WALL RETRACTOR

With DSE Straw Connection

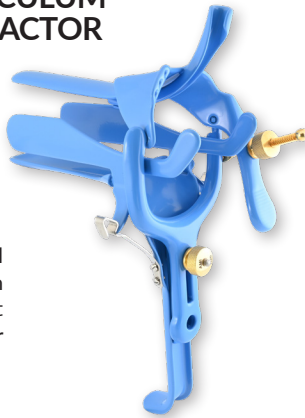

This all-in-one speculum and lateral wall retractor increases visualization of the cervix by retracting redundant vaginal tissue. Especially effective for large or multiparous patients.

Model	Description	Size
L315-320	Medium	3-1/4" x 7/8"
L315-321	Large	4" x 7/8"
L315-322	X-Large	5-1/4" x 1"

NON-CONDUCTIVE LATERAL WALL RETRACTORS

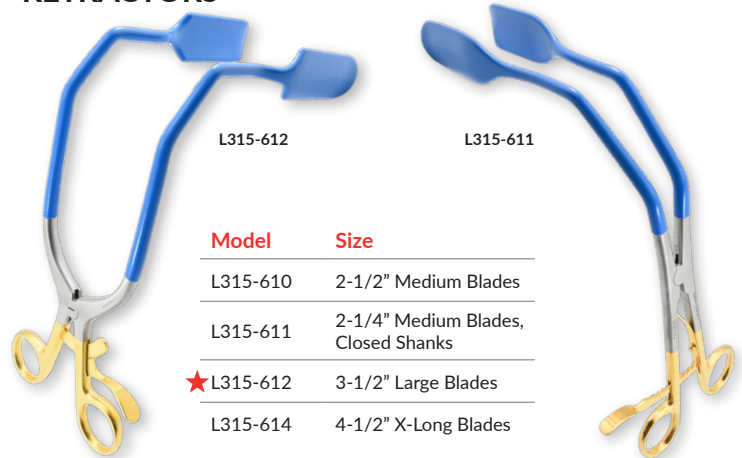

DSE TUBE

With DSE Straw Connection

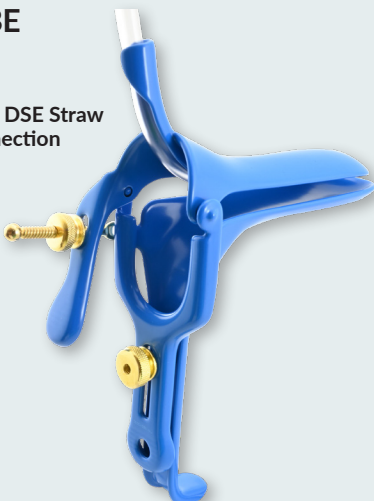

Model	Description	Size
L315-104C	Weisman-Graves (Right Open), Medium	4" x 1-1/2"
L315-103C	Weisman-Graves (Right Open), Large	4-3/4" x 1-1/2"
L315-102C	Weisman-Graves (Left Open), Medium	4" x 1-1/2"
L315-101C	Weisman-Graves (Left Open), Large	4-3/4" x 1-1/2"
L315-111C	Weisman-Pederson (Right Open), Medium	4" x 1"
L315-302C	Graves, Medium	4" x 1-1/2"
L315-303C	Graves, Large	4-3/4" x 1-1/2"
L315-602C	Graves, X-Long	6" x 1-1/2"
L315-605C	Graves, XX-Long	7" x 1-1/2"
L315-502C	Pederson, Medium	4" x 1"
L315-503C	Pederson, Large	4-1/2" x 1"
L315-603C	Pederson, X-Long	6" x 1"

NON-CONDUCTIVE INSTRUMENTS

TENACULA



FOERSTER SPONGE FORCEPS



Model	Description
★ L325-060E	Schroeder, Exposed Tips
L325-060C	Schroeder, Coated Tips
★ L325-070E	Braun, Exposed Tips
L325-070C	Braun, Coated Tips

Model	Description
L140-600	Straight, 9-1/2"
L140-610	Curved, 9-1/2"

KOGAN ENDOCERVICAL SPECULA

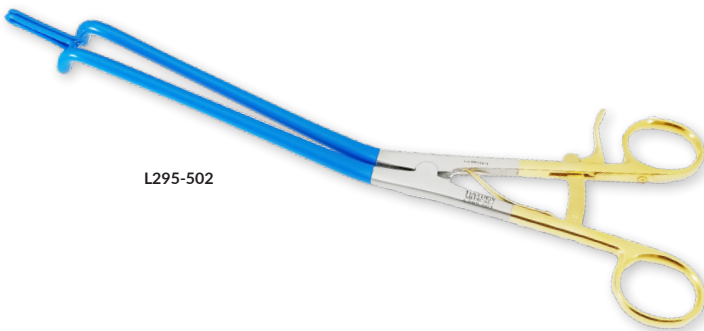

Model	Description
L295-501	Standard Tip with Ratchet
L295-502	Narrow Tip with Ratchet
L295-509	Standard Tip with Set Screw
L295-512	Narrow Tip with Set Screw

DRESSING & TISSUE FORCEPS



Model	Description
★ L120-016C	Dressing 10", Serrated, Coated Tips
L120-016E	Dressing 10", Serrated, Exposed Tips
L120-050C	Tissue 10", 1x2 Teeth, Coated Tips
L120-050E	Tissue 10", 1x2 Teeth, Exposed Tips

CERVICAL HOOKS



NEEDLE EXTENDERS



Model	Description
335-003	3" Stainless Steel
335-004	4" Stainless Steel
335-005	5" Stainless Steel
335-006	6" Stainless Steel



Model	Description
L295-560	Iris, 9"
L295-566	Emmett Half Curve, 9"
L295-564	Emmett Right Angle, 9"
L295-568	Emmett Double Angle, 9"
L295-208	Two-Prong Hook, 10-1/4"

CLINIC | LLETZ INSTRUMENTS

INSTRUMENTS FOR LASER

Ebonized instruments feature a durable, black coating for use in laser surgery procedures. The ebonized finish is designed to absorb stray energy and reduce reflection, thus reducing the risk of injury by laser. Most instruments, including ones not shown ebonized here, can be ebonized for use in laser surgery cases.

LATERAL WALL RETRACTORS

Model	Description
315-611E	Closed Shanks, 2-1/4" Medium Blades
315-612E	Open Shanks, 3-1/2" Large Blades

HOOKS

Model	Description
295-208E	Two Prong Hook, 10-1/4"
295-560E	Iris Hook, 9", Extra Delicate
295-564E	Emmett Hook, 9", Right Angle
295-566E	Emmett Hook, 9", Half Curved
295-568E	Emmett Hook, 9", Double Angled

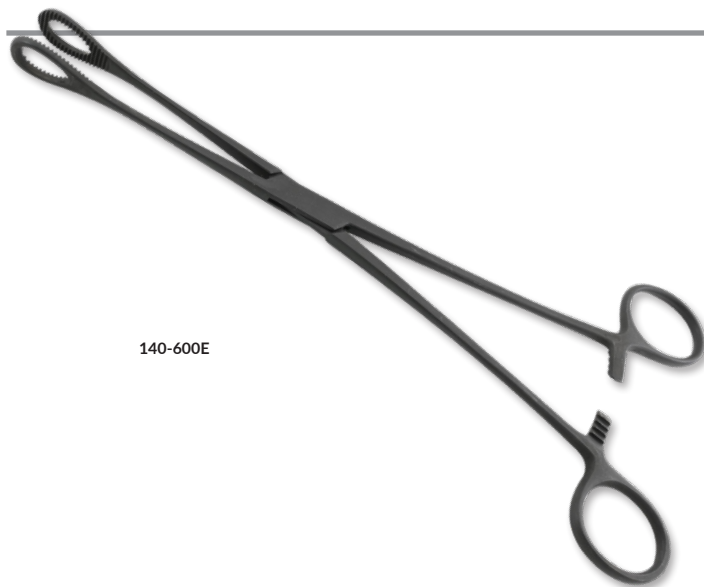

140-600E

FORCEPS

Model	Description
120-016E	Dressing Forceps, 10"
140-600E	Foerster Sponge (Ring) Forceps, 9-1/2"
140-812E	Allis Tissue Forceps, 5x6 Teeth, 10"
325-060E	Schroeder Tenaculum, 10"
325-070E	Braun Tenaculum, 10"



315-302E

SPECULA

Model	Description
315-302E	Graves Speculum with Smoke Tube, Medium 4" x 1-1/2"
315-303E	Graves Speculum with Smoke Tube, Large 4-3/4" x 1-1/2"
315-502E	Pederson Speculum with Smoke Tube, Medium 4" x 1"
315-503E	Pederson Speculum with Smoke Tube, Large 4-1/2" x 1"

WEIGHTED SPECULA WITH SMOKE TUBE

Model	Description
305-907E	Auvard, 2-3/4" x 1-1/2" Blade, 2.5 lbs.
305-909E	Auvard, 3-1/2" x 1-1/2" Blade, 2.5 lbs.
305-910E	Auvard, 4" x 1-3/4" Blade, 2.5 lbs.
305-955E	Steiner, 5-1/2" x 1-1/4" Blade, 2.5 lbs.

ENDOCERVICAL SPECULA

Model	Description
295-501E	Kogan Standard 5mm, with Ratchet
295-502E	Kogan Narrow 3mm, with Ratchet

OB DOPPLERS

OBSTETRIC DISPLAY DOPPLERS



Display Doppler

The D-700 Digital Display obstetric doppler provides a large, bright, back lit display of the heart rate. The display also indicates battery, volume, and signal strength status. The powerful digital processor in the DigiDop utilizes Digital Signal Clarity - DSC to eliminate background noise and amplify a strong clear signal. True auto-correlation calculates a fast, accurate pulse rate.

Model	Description
D-700-D2	Handheld Digidop 700, Display, with 2MHz Obstetrical Probe
D-700-D3	Handheld Digidop 700, Display, with 3MHz Obstetrical Probe
D-700R-D2	Handheld Digidop 700, Display, with 2MHz Obstetrical Probe, Rechargeable
D-700R-D3	Handheld Digidop 700, Display, with 3MHz Obstetrical Probe, Rechargeable

OBSTETRIC NON-DISPLAY DOPPLERS



Non Display – Audio Only

These audio only Dopplers provide great value if all you need is to hear the Doppler sounds loud and clear. They include a display of battery condition, signal strength, and volume setting, but do not have a heart rate display.

Model	Description
D-330-D2	Handheld Digital Doppler, Non-Display, with 2MHz Obstetrical Probe
D-330-D3	Handheld Digital Doppler, Non-Display, with 3MHz Obstetrical Probe
D-330R-D2	Handheld Digital Doppler, Non-Display, with 2MHz Obstetrical Probe, Rechargeable
D-330R-D3	Handheld Digital Doppler, Non-Display, with 3MHz Obstetrical Probe, Rechargeable

PROBES

All DigiDop obstetrical probes provide the sensitivity and reliability you need. All probes will work on all DigiDops for maximum versatility. Our 2 and 3 MHz obstetrical probes utilize our exclusive eXtended Depth - XD™ technology that has increased sensitivity at closer depths without sacrificing it at deeper depths. These probes create more than six times as much signal at some depths that other probes. All our OB probes have a smooth contour design that is comfortable to hold, comfortable for the patient, and easy to clean.

- 2 MHz probes provide excellent deep penetration for late term pregnancy or larger patients.
- 3 MHz probes are especially sensitive to early fetal hearts but can also be used throughout the pregnancy.
- Both 2 and 3 MHz probes are available in water proof versions for water-assisted labor and delivery. These waterproof probes can be removed from the DigiDop and replaced with a standard probe.
- A variety of vascular probes can be interchangeably used with any of the DigiDops.

COLPOSCOPES

CENTER POST ZOOM

A compact Center-Post Colposcope with unique, continuous zoom magnification and sharp focusing for crisp 3-D imaging. The unit is excellent for the facility performing gynecological exams where millimeters matter.

Model	Description
HCS-205LED	Binocular Zoom Center Post Colposcope
HCS-205T-LED	Camera Ready Zoom Center Post Colposcope
HCS-205T-HD	HDMI Video Zoom Center Post Colposcope



Camera-Ready Trinocular Head with Camera Mount



CENTER POST TRIPLE MAG

This Triple Magnification, LED Illuminated Center-Post Colposcope is designed to be simple and easy to use, featuring brilliant, sharp optics and three magnification settings: 3.75x, 7.5x and 15x. Changing magnification is a simple rotation of the knob, and the colposcope maintains focus. The state of the art LED illumination provides bright, white light that will not burn out, or burn too hot! Available with a wheeled or pedestal base.



SWING ARM ZOOM

Perfect for the GYN performing both exams and procedures. The swing-arm design allows easy access to the vaginal canal during procedure aiding procedure efficiency.



Model	Description
HCS-103LED	Binocular Zoom Swing Arm Colposcope
HCS-103T-LED	Camera Ready Zoom Swing Arm Colposcope
HCS-103T-HD	HDMI Video Zoom Swing Arm Colposcope

Model	Description
★ HCS-305	Binocular Triple Magnification Center Post Colposcope

All Colposcopes Include:

7 Years Limited Warranty • 1 Year on Electrical System (Excludes Bulbs and Fuses) • Dust Cover, Power Cord, Manual & Tool Kit

CRYO SYSTEMS

Fast, precision freeze and thaw control. Our one and two-trigger systems provide precise control and a large selection of highly conductive reusable cryotips and disposable plastic shields are available.

LL100™ SYSTEM (N2O)

Two-trigger design and twice the freeze power of other systems, this exclusive two-trigger cryosurgical system delivers fast and precise freeze/defrost control and allows cryotips to be changed at any time without venting.



- Large selection of cryotips and disposable plastic shields available
- More effective freeze/defrost in less time
- Lightweight, well-balanced, and maneuverable
- Freeze and defrost only when triggered

Model	Description
W900001	LL100 Cryosurgical System, N2O (Freezer Only)
W900160	LLCO2 Cryosurgical System, CO2 (Freezer Only)
HM019011A	British Adapter Assembly for N2O

WA1000B™ CRYO CONSOLE SYSTEM

Uses LL100™ two-trigger or LLCO2™ single-trigger freezers

- High-performance features and easy-to-use controls
- Temperature indicator with integrated timer for precise documentation
- Cart carries a single 20 lb. cylinder
- Large selection of cryotips and shields



LLCO2™ SYSTEM



Single-trigger design is optimized for CO2 gas. The LLCO2 single-trigger cryosurgical system maximizes temperature and minimizes the clogging and sputtering commonly associated with CO2 gas.

- Squeeze trigger to freeze; release to defrost
- Use with medical-grade CO2 gas for optimal performance
- Use with standard cryotips with disposable plastic shields

Model	Description
W900506-1-N2O	WA1000B Cryosurgical Console, Blank N2O LL100
W900506-1-CO2	WA1000B Cryosurgical Console, Blank CO2 LL100
W900506-2-N2O	WA1000B Cryosurgical Console, Digital Temp. (N2O) Indicator, Timer, Base and LL100
W900506-2-CO2	WA1000B Cryosurgical Console, Digital Temp. (CO2) Indicator, Timer, Base and LLCO2

Both the LL100 and the LLCO2 are available in three-tip package specials for additional savings. Choose three cryotips from our comprehensive offerings when ordering. We recommend the T-1905, T-2514, and T-0500 for GYN procedures and the T-0524, T-0219, and T-1900 for general/family practice procedures. Call Hayden Medical customer service for more information.

CLINIC | CRYO SYSTEMS

CRYO SYSTEM TIPS

Cryo surgical tips for use with LL100™ and LLCO2™
Highly conductive, thermal, reusable, sterilizable cryotips with disposable plastic shields.



W900200AA
T-0219 Microderm



W900201AA
T-0219 Cone



W900202AA
T-0524 Bevel



W900203AA
T-0519 Condyloma



W900204AA
T-0832 Procto



W900205AA
T-0819 General Purpose



W900206AA
T-0826 Cone Tip



W900207AA
T-0823 Bevel



W900208AA
T-1900 Flat



W900209AA
T-1905 Long
Exo-Endocervical



W900210AA
T-1920 Exo-Endocervical



W900211AA
T-1910 Exo-Endocervical



W900212AA
T-1920 Long
Exo-Endocervical



W900213AA
T-2500 Flat



W900214AA
T-2507 Exocervical



W900215AA
T-2514 Exo-Endocervical



W900217AA
T-0832 Procto Curved



W900300AA
T-0200 2.5mm HPV



W900301AA
T-0500 5mm HPV



W900302AA
T-0700 7mm HPV



W900303AA
T-0900 9mm HPV



W900305AA
T-1300 13.5mm HPV



W900306AA
T-1500 15mm HPV

HYSTEROSCOPY

In-office hysteroscopy scopes & sheaths for ablation and female sterilization procedures.

DIAGNOSTIC HYSTEROSCOPY

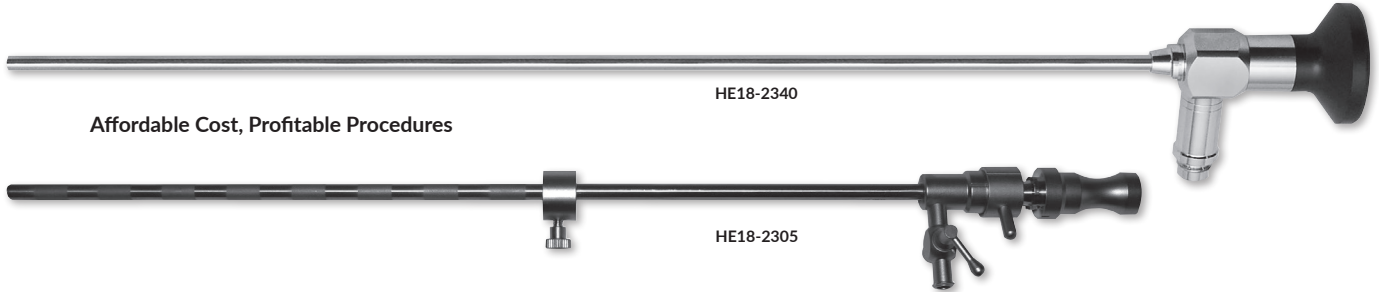

Affordable Cost, Profitable Procedures

Model	Description
HE18-2340	4mm Hysteroscope, 0°, 30cm (Autoclavable)
HE18-2341	4mm Hysteroscope, 30°, 30cm (Autoclavable)
HE18-2305-0	Diagnostic Hysteroscopy Sheath for 4mm Hysteroscopes, 0°
HE18-2305	Diagnostic Hysteroscopy Sheath for 4mm Hysteroscopes, 30°

Model	Description
HE18-2306-0	Diagnostic Hysteroscopy Sheath for 2.7mm Hysteroscopes, 0°
HE18-2306	Diagnostic Hysteroscopy Sheath for 2.7mm Hysteroscopes, 30°
450-678	10' Fiber-Optic Cable (Autoclavable), Specify Connection

OPERATIVE HYSTEROSCOPY

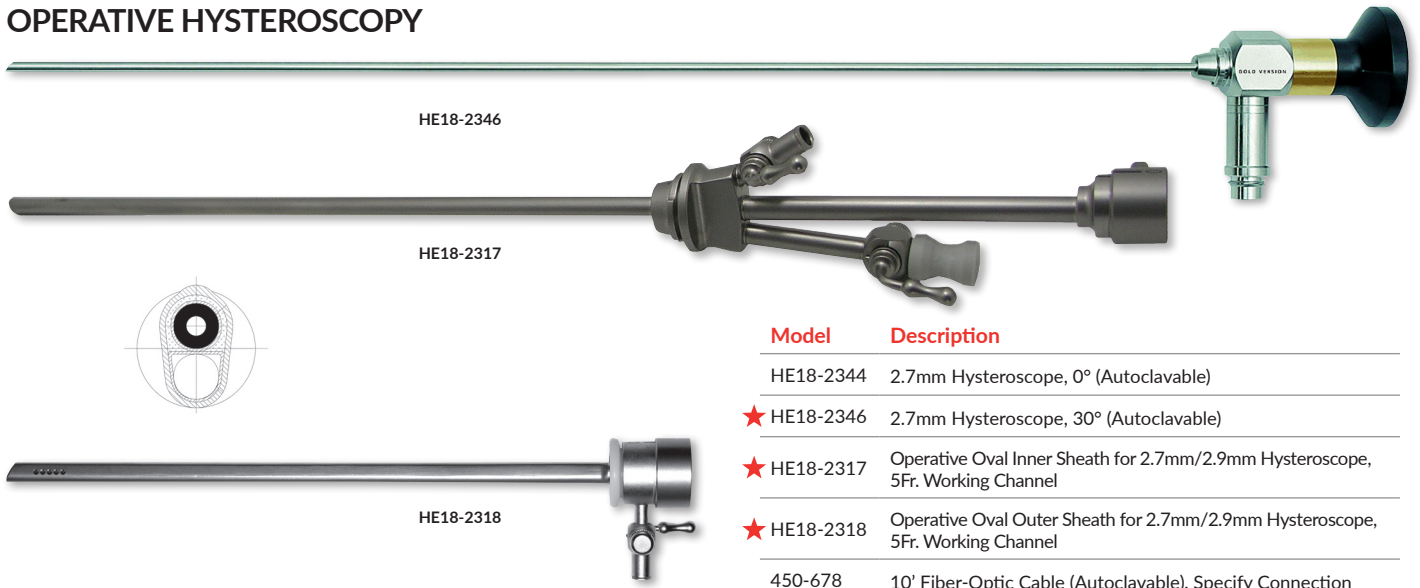

Model	Description
HE18-2344	2.7mm Hysteroscope, 0° (Autoclavable)
★ HE18-2346	2.7mm Hysteroscope, 30° (Autoclavable)
★ HE18-2317	Operative Oval Inner Sheath for 2.7mm/2.9mm Hysteroscope, 5Fr. Working Channel
★ HE18-2318	Operative Oval Outer Sheath for 2.7mm/2.9mm Hysteroscope, 5Fr. Working Channel
450-678	10' Fiber-Optic Cable (Autoclavable), Specify Connection

SEMI-RIGID INSTRUMENTS

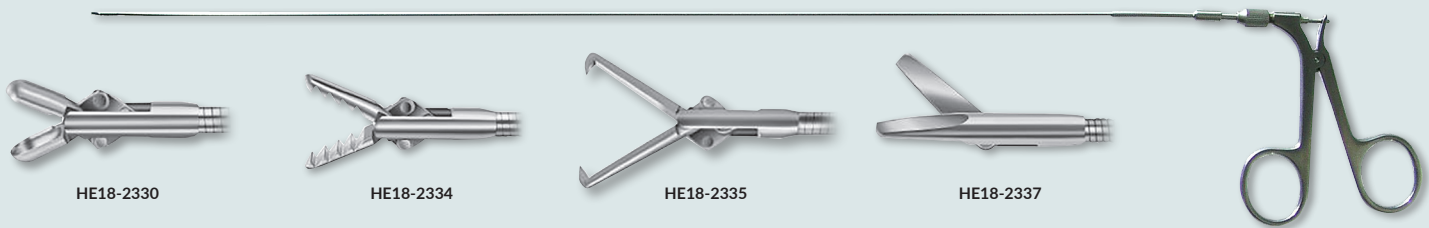

Model	Description
HE18-2330	Oval Spoon Biopsy Forceps, Double Action, Semi-Rigid, 5Fr., 40cm
★ HE18-2334	Alligator Grasping Forceps, Double Action, Semi-Rigid, 5Fr., 40cm
HE18-2335	Tenaculum Forceps, Double Action, Semi-Rigid, 5Fr., 40cm
HE18-2337	Scissors, Single Action, Semi-Rigid, 5Fr., 40cm

Other instrument options are available.

Cameras, Light Sources & Monitors Also Available.

LED LIGHT SOURCES

50W LED LIGHT SOURCE



- 50w solid state LED light, lumen output comparable to 150w halogen
- Compact, efficient, durable "daylight" light
- Color temperature: 6500° K nominal
- Typical LED life: >50,000 hours
- Multi turret ports are ACMI, Olympus, Storz, and Wolf
- Accepts 100-240V AC, 50/60 Hz input power for worldwide operation
- Dimensions: 4.65"W x 3.32"H x 7.25"D (~10"overall) Weight: 1.14 kg (2.5 lbs.)

Model

LS-200LED

LED LIGHT SOURCE (180W XENON EQUIVALENT)



- Lumen output comparable to 180w Xenon units but more stable and consistent
- Expected LED life of 30,000 hours (15 years @ 40 hrs./week x 50 weeks/year) eliminates costly periodic lamp changes
- Color temperature: 6950°K
- Ergonomically designed turret includes ACMI, Olympus, Storz, & Wolf ports LED automatically shuts off when cable is removed from active port
- Accepts 100-240V AC, 50/60 Hz input power for worldwide operation
- Dimensions: 11"W x 4.5"H x 11"D Weight 3.4kg (7.5 lbs.)

Model

LS-180LED

LED LIGHT SOURCE (300W XENON EQUIVALENT)



- Lumen output comparable to 300w Xenon units but more stable and consistent
- Expected LED life of 30,000 hours (15 years @ 40 hrs./week x 50 weeks/year) eliminates costly periodic lamp changes
- Color temperature: 6500°K @ 75 CRI or 5600°K @ 92 CRI
- Accepts 100-240V AC, 50/60 Hz input power for worldwide operation
- Dimensions: 11"W x 4.5"H x 11"D weight 3.4kg (7.5 lbs.)

Model

LS-300LED

OR | LED LIGHT SOURCES

DOCTOR'S STOOL

DOCTOR STOOL WITH AIRLIFT & BACK REST

- Extra-Large, Fully Rotating Seat: 15" Diameter; larger than most seats
- Adjustable Pneumatic Height Range: 17" to 23" (ADA compliant)
- NEW Soft Polyurethane Wheels: Maneuvers smoothly over hardwood floors and carpets
- 4" of our Exclusive Small Cell™ Foam: Delivers superior comfort through the years
- Extra Large, Steel Seat Mounting Plate: 2x Larger than other stools; maintains durability and safety
- Hypoallergenic, CFC-free, oil & waterproof upholstery



Model

Description

EDS-1060G

With Backrest

EDS-1060

Without Backrest

MIYAZAKI INSTRUMENTS

MIYAZAKI ALL-PURPOSE RETRACTOR™

MIYAZAKI SACROPEXY RETRACTOR™



Model	Description
★ 254-630	Includes 10' Light Cable
254-636	Replacement Light Cable, Olympus connection

Model	Description
254-632	Includes 10' Light Cable
254-636	Replacement Light Cable, Olympus connection

MIYAZAKI TACK DRIVER

The Miyazaki Tack Driver Set™ facilitates easier placement of the Hemorrhage Occluder Pin.



Model	Description
★ 335-195	Miyazaki Tack Driver™
335-198	Miyazaki Mallet

HEMORRHAGE OCCLUDER PIN

Made of Titanium and designed to control presacral hemorrhage during pelvic surgery. Life saving and cost effective, the Hemorrhage Occluder Pin is a must for any operating room performing surgery near the sacrum. The ribbed shaft (7mm depth) ensures secure placement to prevent withdrawal or migration.



Model	Description
335-201	Sterile Titanium Pin, Each
335-202	Sterile Titanium Pin, Box of 2
★ 335-205	Sterile Titanium Pin, Box of 5

MIYAZAKI HOOK

The Miyazaki Hook was the first ligature carrier designed specifically for sacrospinous suspension.



Model	Description
335-180	Miyazaki Hook
315-250	Notched Speculum
310-620	Breisky Navratil Retractor, 170 x 25mm
295-570S	Suture Retrieval Hook, Sharp

FIBER-OPTIC RETRACTORS

HEANEY-SIMON



Model	Description
310-950L	4-1/2" x 1"

BREISKY-HARRINGTON



Model	Description
310-622L	170mm x 25mm, Heart Shaped Tip

YANKAUER SUCTION TUBE



Model	Description
190-607L	11" Length, 6Fr. Hole

ST. MARK'S



Model	Description
240-580L	5" Straight Blade with Lip
240-581L	7" Straight Blade without Lip
240-582L	7" Straight Blade with Lip
240-586L	7" Angled Blade with Lip
240-585L	7" Narrow tapers to 3-1/2cm's
240-583L	9" Angled Blade with Lip
240-583SL	9" Straight Blade with Lip
240-589L	9" Double Angled Blade with Lip
240-584L	11" Angled Blade with Lip
240-587L	13" Angled Blade with Lip

DEEP DEEVER



Model	Description
240-700L	1" x 13"
240-701L	2" x 13"
240-702L	3" x 13"
240-703L	4" x 13"

WYLIE DEEP PELVIC

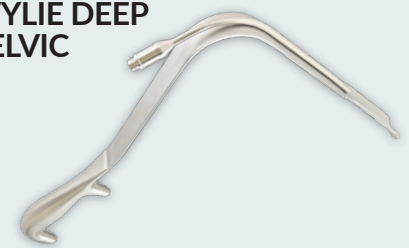

Model	Description
240-607L	7" x 1" with Lip
240-608L	8" x 1" with Lip
240-610L	10" x 1" with Lip

All Fiber-Optic Retractors Have A Universal Light Cable Connection.

OR | FIBER-OPTIC RETRACTORS

FIBER-OPTIC LIGHT CABLES

FIBER-OPTIC LIGHT CABLES



Autoclavable

Model	Description
450-678/20	10' x 2mm Fiber Bundle
450-678/35	10' x 3.5mm Fiber Bundle
450-678/50	10' x 5mm Fiber Bundle
450-679/35	12' x 3.5mm Fiber Bundle
450-679/5	12' x 5mm Fiber Bundle

LIGHT SOURCE ADAPTERS



Model	Description
450-AC900	ACMI / Stryker / Olympus
450-ST900	STORZ
450-WO900	Wolf / Dyonics / Weck / Linvatec

INSTRUMENT ADAPTERS



Model	Description
450-AC800C	ACMI / Stryker / Olympus
450-ST800	STORZ
450-WO800	Wolf / Dyonics / Weck / Linvatec

Most Popular Sizes Listed. More Available By Request.

Z-BEST HYSTERECTOMY CLAMPS

Z-BEST CLAMPS™ FOR HYSTERECTOMY

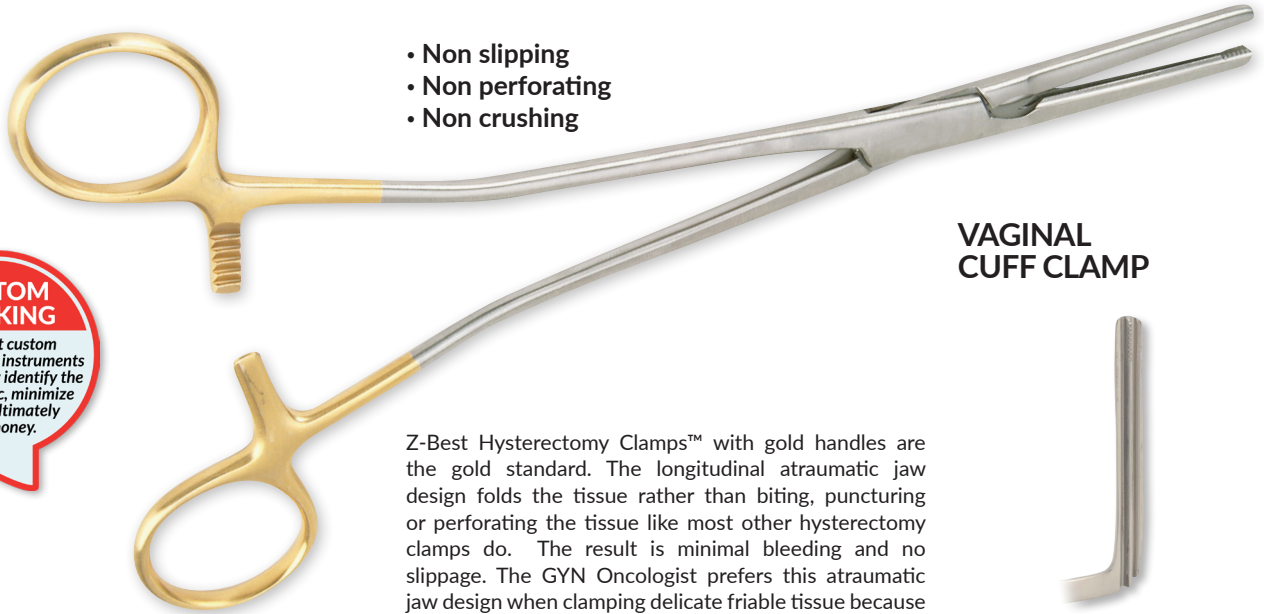

- Non slipping
- Non perforating
- Non crushing

VAGINAL CUFF CLAMP



CUSTOM MARKING
Ask about custom marking your instruments to help better identify the correct clinic, minimize loss and ultimately save money.

ZBCA-24

Z-Best Hysterectomy Clamps™ with gold handles are the gold standard. The longitudinal atraumatic jaw design folds the tissue rather than biting, puncturing or perforating the tissue like most other hysterectomy clamps do. The result is minimal bleeding and no slippage. The GYN Oncologist prefers this atraumatic jaw design when clamping delicate friable tissue because it holds better than the traditional Heaney, Ballentine, Rogers or Masterson designs. Whether working deep in the pelvis on obese patients or a routine hysterectomy, use the clamp that doesn't slip.

Model	Description
ZBCE-24	9-1/2" (24cm), 50mm Jaw
ZBCE-30	12" (30cm), 60mm Jaw

STRAIGHT



Model	Description
ZBCA-21	8-1/4" (21cm)
ZBCA-24	9-1/2" (24cm)
ZBCA-30	12" (30cm)
ZBCA-35	14" (35cm)
ZBCA-40	16" (40cm)
ZBCA-45	18" (45cm)

SLIGHTLY CURVED



Model	Description
ZBCB-21	8-1/4" (21cm)
ZBCB-24	9-1/2" (24cm)
ZBCB-30	12" (30cm)
ZBCB-35	14" (35cm)
ZBCB-40	16" (40cm)
ZBCB-45	18" (45cm)

STRONGLY CURVED



Model	Description
ZBCC-21	8-1/4" (21cm)
ZBCC-24	9-1/2" (24cm)
ZBCC-30	12" (30cm)
ZBCC-35	14" (35cm)
ZBCC-40	16" (40cm)
ZBCC-45	18" (45cm)

ANGLED



Model	Description
ZBCD-21	8-1/4" (21cm)
ZBCD-24	9-1/2" (24cm)
ZBCD-30	12" (30cm)
ZBCD-35	14" (35cm)
ZBCD-40	16" (40cm)
ZBCD-45	18" (45cm)

Z-BEST IFP CLAMP™

Model	Description
ZBIFP-11	11" (28cm), S-Curved
ZBIFP-13	13" (33cm), S-Curved



ZBIFP-11

The Z-Best IFP Clamp™ is perfectly shaped to reach high into the pelvis during vaginal hysterectomy salpingo-oophorectomy (BSO). The 70mm jaw length allows clamping of the infundibular pelvic ligament and round ligament simultaneously. The 11" length will work for the majority of your patients while the 13" length will also accommodate larger patients. The S-Shaped shanks allow the surgeon's hands to be out of the way during surgery.

OR | HYSTERECTOMY CLAMPS

PELVIC SURGERY INSTRUMENTS

Z-BEST SCISSORS™ FOR HYSTERECTOMY

Z-Best Hysterectomy Scissors™ are a complete set of TC Parametrium scissors designed to match the Z-Best Hysterectomy Clamp™ jaw curvatures. The Z-Best Scissors™ have tungsten carbide blades with one blade serrated. The result is a scissors that stays sharper longer, allowing the surgeon to cut with the tip of the blades without the tissue slipping out of the blade tips. Don't settle for your existing scissors. Try Z-Best Scissors™ today.

Hayden Medical, Inc. has a wide variety of hysterectomy instruments. The instruments you see here are the daily tools of GYN Oncologists and Pelvic Surgeons.



SLIGHTLY CURVED



Model	Description
ZBSB-23	9" (23cm)
ZBSB-26	10-1/2" (26cm)
ZBSB-30	12" (30cm)
ZBSB-35	14" (35cm)
ZBSB-40	16" (40cm)
ZBSB-45	18" (45cm)

STRONGLY CURVED



Model	Description
ZBSC-23	9" (23cm)
ZBSC-26	10-1/2" (26cm)
ZBSC-30	12" (30cm)
ZBSC-35	14" (35cm)
ZBSC-40	16" (40cm)
ZBSC-45	18" (45cm)

ANGLED (JORGENSEN)



Model	Description
ZBSD-23	9" (23cm)
ZBSD-26	10-1/2" (26cm)
ZBSD-30	12" (30cm)
ZBSD-35	14" (35cm)
ZBSD-40	16" (40cm)
ZBSD-45	18" (45cm)

NOLAN NEEDLE HOLDER

The unique extended boxlock design and thicker shanks minimize twisting of the needle holder. The needle stays secure in the tungsten carbide jaws and does not move around haphazardly during suturing. The extended boxlock on the longer length Nolan's increase safety and reduce O/R time during deep pelvic cases.

Model	Description
520-865	10" Straight TC Jaw
520-870	12" Straight TC Jaw
520-870XL	14" Straight TC Jaw
520-870XXL	16" Straight TC Jaw
520-871	12" Curved TC Jaw
520-871XL	14" Curved TC Jaw
520-871XXL	16" Curved TC Jaw

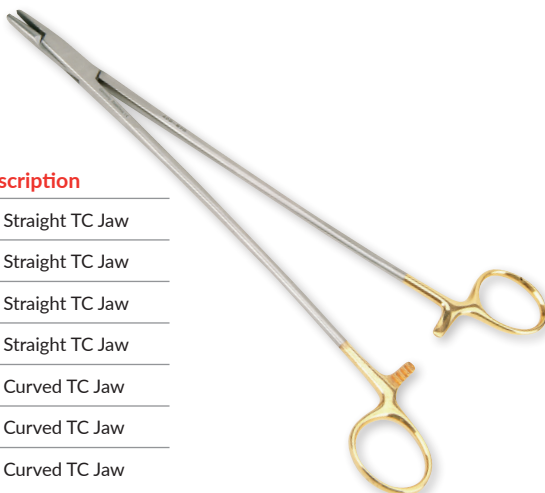

KROBACH TISSUE CLAMP

The 10" long Krobach Tissue Clamp is ideal to grasp the posterior vaginal wall and perianal tissue when dissecting in the pararectal space.

Model	Description
345-240	7mm Wide Jaw
345-242	10mm Wide Jaw

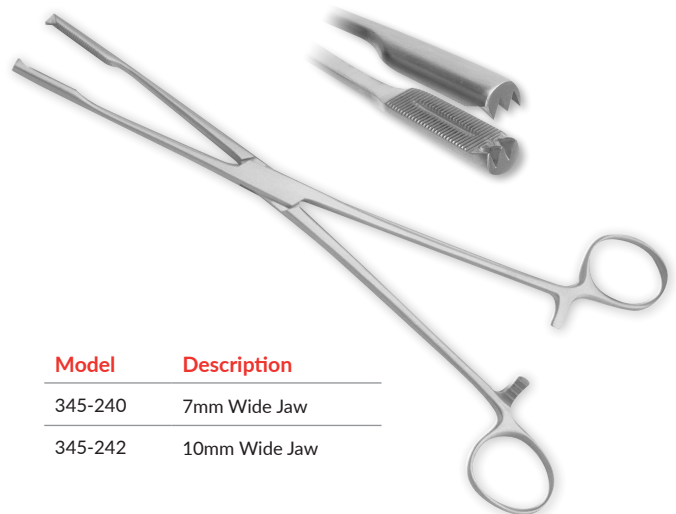

PELVIC SURGERY INSTRUMENTS

MD ANDERSON CLAMP

The MD Anderson Clamp is ideal for clamping adnexal tissue during hysterectomy. It's delicate blunt tip is ideal for dissecting around the ureters during pelvic surgery. The longitudinal atraumatic serrations of the slightly curved jaw add a margin of safety from accidental ureter trauma.



Model	Description
345-125	10"
345-128	11"
345-128XL	14"
345-128XXL	16"

CLARK CLAMP

The Clark Clamp side curve is ideal for tunneling around ureters during pelvic surgery. The atraumatic longitudinal serrations increase the margin of safety from accidental ureter damage.



Model	Description
345-021	8-3/4"
345-022	12"
345-022XL	14"
345-022XXL	16"

BOZEMAN-HEANEY NEEDLE HOLDER

The offset shaft on the Bozeman-Heaney tungsten carbide needle holder minimizes torquing and allows for better visualization of the jaw for more accurate needle placement.

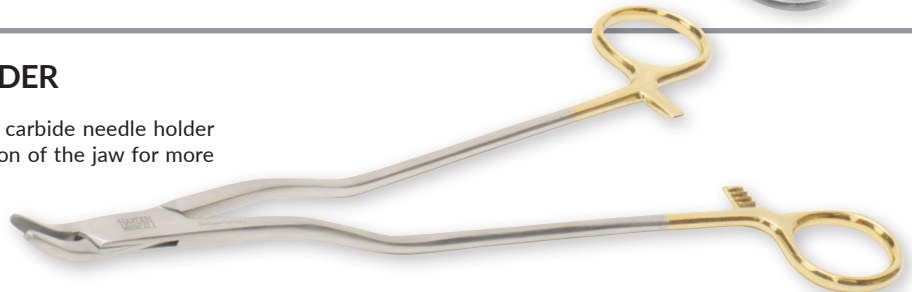

Model	Description
520-646	10-1/2"

FASCIA HARVESTER

Designed for precise harvesting of fascia lata.

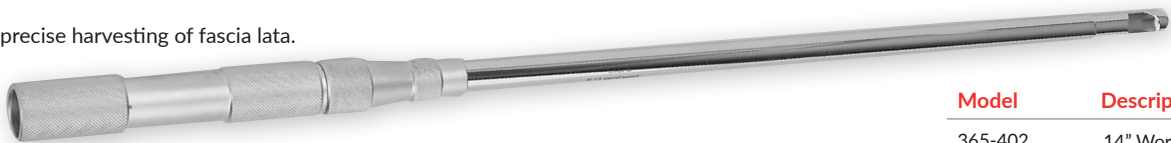

Model	Description
365-402	14" Working Length

Singley and Russian forceps have a broad, serrated tip and are most useful in grasping thicker vascular tissues such as myometrium, when the toothed instrument may cause penetration and bleeding.

SINGLEY TISSUE FORCEPS

Fenestration is ideal in atraumatic handling of tissue bundles during lymphatic dissection.

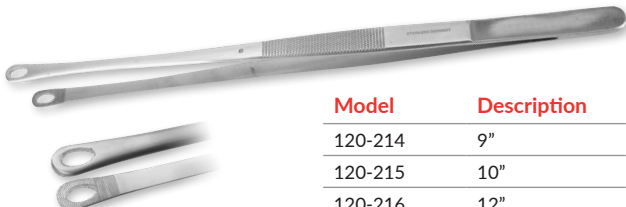

Model	Description
120-214	9"
120-215	10"
120-216	12"

RUSSIAN TISSUE FORCEPS

Russian forceps have a large atraumatic grasping surface for heavy or thick tissue.

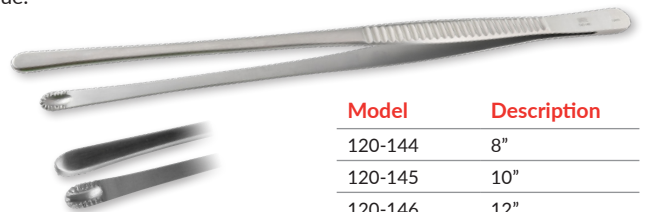

Model	Description
120-144	8"
120-145	10"
120-146	12"

PELVIC SURGERY INSTRUMENTS

MCCALL STYLE UTEROSACRAL CLAMP

The McCall style pedical clamp is specifically shaped to firmly grab the uterosacral pedicle while positioning suture. Solid jaws disallow inadvertent suturing of the clamp to the ligament.



Model	Description
345-252	9"

HULKA UTERINE MOBILIZER TENACULA

11-1/4" (28.1cm)

Model	Description
365-201	Insulated
365-203	Toothed Tenaculum
365-209	Atraumatic Tenaculum



VAGINAL RETRACTORS

BREISKY RETRACTORS

Ideal for vaginal surgery.



Model	Description	Model	Description
310-407	100mm x 18mm	310-514	130mm x 35mm
310-410	100mm x 25mm	310-516	140mm x 35mm
310-412	100mm x 30mm	310-613	150mm x 35mm
310-414	100mm x 35mm	310-615	160mm x 35mm
310-415	100mm x 38mm	★ 310-620	170mm x 25mm, Navratil
310-512	120mm x 30mm	310-622	170mm x 25mm, 35mm Wide Sweetheart Tip

WEIGHTED SPECULA

STEINER

2-1/2 lbs.

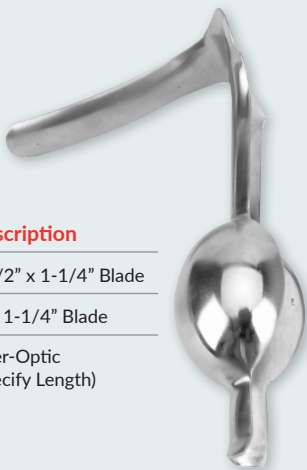

Model	Description
★ 305-955	5-1/2" x 1-1/4" Blade
305-958	7" x 1-1/4" Blade
305-950	Fiber-Optic (Specify Length)

HARDY-DUDDY

2-1/2 lbs.



Model	Description
305-920	4-3/4" x 2" U-Shaped Design

AUVARD

2-1/2 lbs.

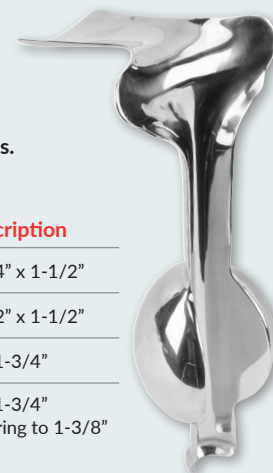

Model	Description
305-907	2-3/4" x 1-1/2"
305-909	3-1/2" x 1-1/2"
305-910	4" x 1-3/4"
305-911	4" x 1-3/4" Tapering to 1-3/8"

MARTIN'S ARM RETRACTORS

MARTIN'S ARMS

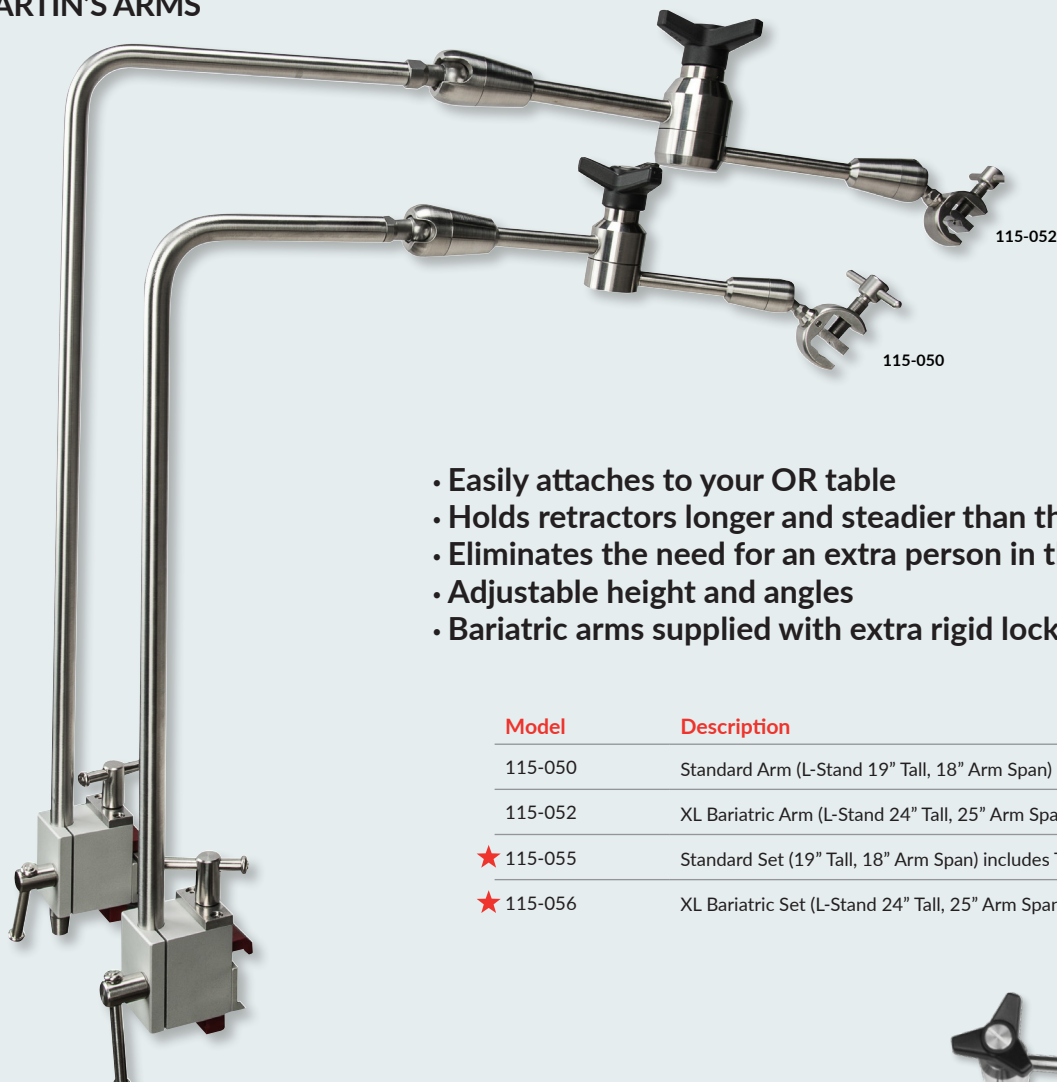

- Easily attaches to your OR table
- Holds retractors longer and steadier than the human hand
- Eliminates the need for an extra person in the operating field
- Adjustable height and angles
- Bariatric arms supplied with extra rigid locking mechanism

Model	Description
115-050	Standard Arm (L-Stand 19" Tall, 18" Arm Span)
115-052	XL Bariatric Arm (L-Stand 24" Tall, 25" Arm Span)
★ 115-055	Standard Set (19" Tall, 18" Arm Span) includes Table Clamp
★ 115-056	XL Bariatric Set (L-Stand 24" Tall, 25" Arm Span) Includes Table Clamp

OR | MARTIN'S ARM RETRACTOR

STERILIZATION BASKET

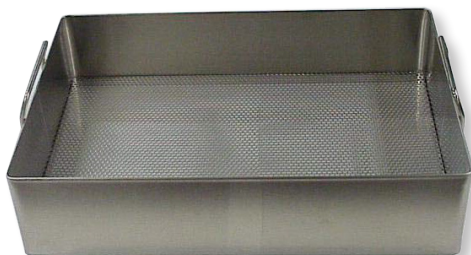

HB20-1020

SCOPE HOLDING RETRACTOR



Model	Description
115-062	16" Straight Column with 16" Arm Length and Plastic Delrin Scope Holder (3mm to 12.7mm Diameter) Attached

Model	Description
HB20-1020	10-1/2" W x 20" L x 3-1/2" H for Standard Arm
HB20-1324	13" W x 24" L x 4" H for XL Bariatric Arm

QUICK-CONNECT RETRACTOR & ACCESSORIES

QUICK-CONNECT MARTIN'S ARM



Model	Description
115-050QC	Standard Arm (L-Stand 19" Tall, 18" Arm Span), Quick-Connect
115-052QC	XL Bariatric Arm (L-Stand 24" Tall, 25" Arm Span), Quick-Connect
115-055QC	Standard Set includes Table Clamp, Quick-Connect
115-056QC	XL Bariatric Set includes Table Clamp, Quick-Connect

TABLE CLAMPS

STANDARD



Model	Description
★ 115-060	Aluminum

ROTATING

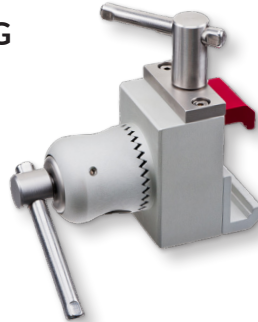

Model	Description
115-060R	Aluminum

HEAVY DUTY ROTATING



Model	Description
115-060HR	Stainless Steel

OR | LIVER RETRACTORS

QUICK-CONNECT ACCESSORIES

UNIVERSAL RETRACTOR HOLDER

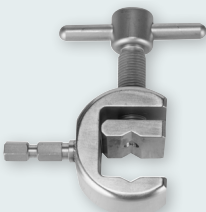

Model	Description
115-300QC	C-Clamp, Quick-Connect

DELTRIN LOCKING SCOPE HOLDER

Model	Description
115-305QC	(3mm to 12.7mm Dia.), Quick-Connect



SWIVEL DELTRIN LOCKING SCOPE HOLDER

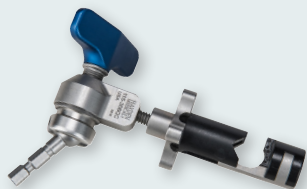

Model	Description
115-306QC	(3mm to 12.7mm Dia.), Quick-Connect

LIVER RETRACTORS

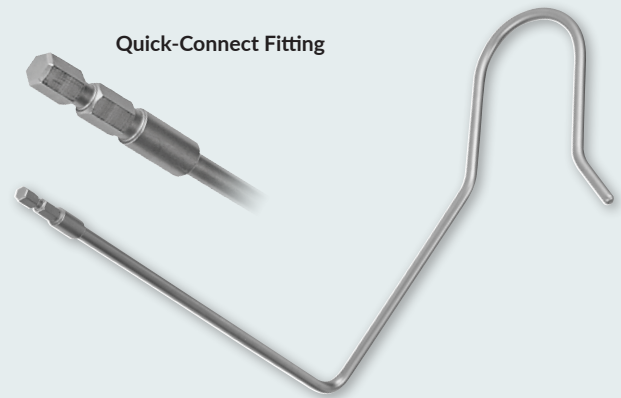

Model	Description
★ H13-1680QC	6.5mm Dia., Small
★ H13-1681QC	6.5mm Dia., Medium
★ H13-1682QC	6.5mm Dia., Large
H13-1680QC-5	5mm Dia., Small
H13-1681QC-5	5mm Dia., Medium
H13-1682QC-5	5mm Dia., Large

Snake Retractors

Ideal in the peritoneal cavity for retraction of organs and structures.



TRIANGULAR



Model	Description
HE13-1666	80mm WL, 34cm
HE13-1666-6	60mm WL, 34cm
HE13-1666-12	120mm WL, 34cm
HE13-1666-45	80mm WL, 45cm

TRIANGULAR, ANGLED IN SHEATH



Model	Description
HE13-1665	80mm WL, 34cm
HE13-1665-6	60mm WL, 34cm
HE13-1665-45	80mm WL, 45cm

*WL - Working Length

STRAIGHT, CIRCULAR



Model	Description
HE13-1662	40mm WL, 34cm

ANGLED SHEATH, CIRCULAR



Model	Description
HE13-1663	40mm WL, 34cm

RIGHT CURVED, ANGLED IN SHEATH



Model	Description
HE13-1667R	34cm

LEFT CURVED, ANGLED IN SHEATH



Model	Description
HE13-1667L	34cm

CURVED RIGHT, HOOKED



Model	Description
HE13-1664R	34cm

CURVED LEFT, HOOKED



Model	Description
HE13-1664L	34cm

STRAIGHT



Model	Description
HE13-1667	34cm

STRAIGHT, ANGLED IN SHEATH



Model	Description
HE13-1661	34cm

OR | SNAKE RETRACTORS

LAPAROSCOPY UTERINE MANIPULATOR INJECTORS

DISPOSABLE UTERINE MANIPULATOR INJECTORS

Ideal for:

- Laparoscopic tubal occlusion
- Minilaparotomy
- Salpingoplasty
- Fertility exams
- Chromotubation
- Diagnostic laparoscopy

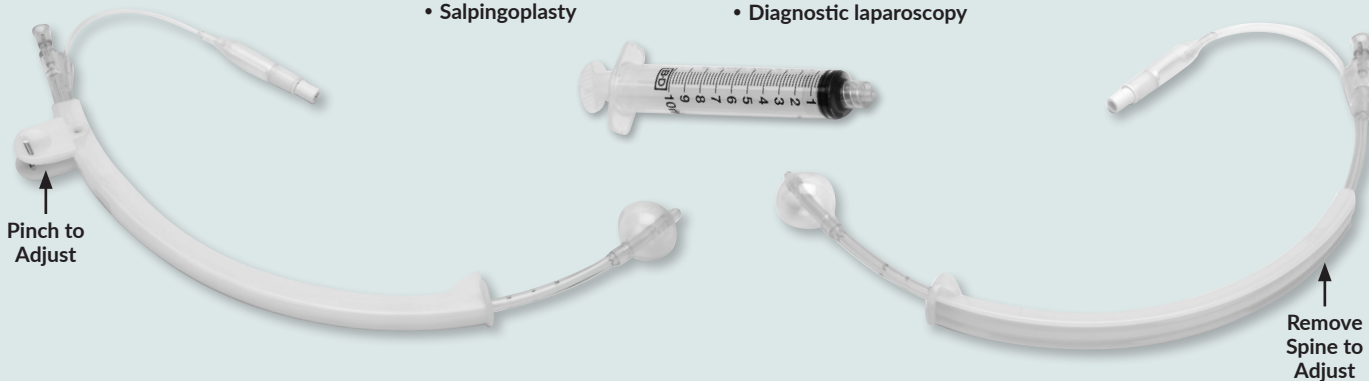

Model	Description
★ HM6003	Adjustable Uterine Manipulator Injector 4.5mm, Box of 12, Individually Sterile

Model	Description
HM6002	Uterine Manipulator Injector 4.5mm, Box of 12, Individually Sterile

HAYDEN UTERINE MANIPULATOR / INJECTOR

The Hayden Manipulator offers the latest ergonomically designed reusable manipulator with interchangeable tips yet. German engineered and priced affordably for your hospital.



Model	Description
365-210	Hayden Uterine Manipulator Injector - Complete with Six Tips
365-211	Manipulator Only - No Tips
365-212	3.2mm x 34mm Injector Tip
365-213	3.2mm x 45mm Injector Tip
365-214	3mm x 45mm Manipulator Tip
365-215	3mm x 55mm Manipulator Tip
365-216	8mm x 80mm Manipulator Tip
365-217	10mm x 100mm Manipulator Tip
030-112	Sterilization Case for HM Uterine Manipulator Set

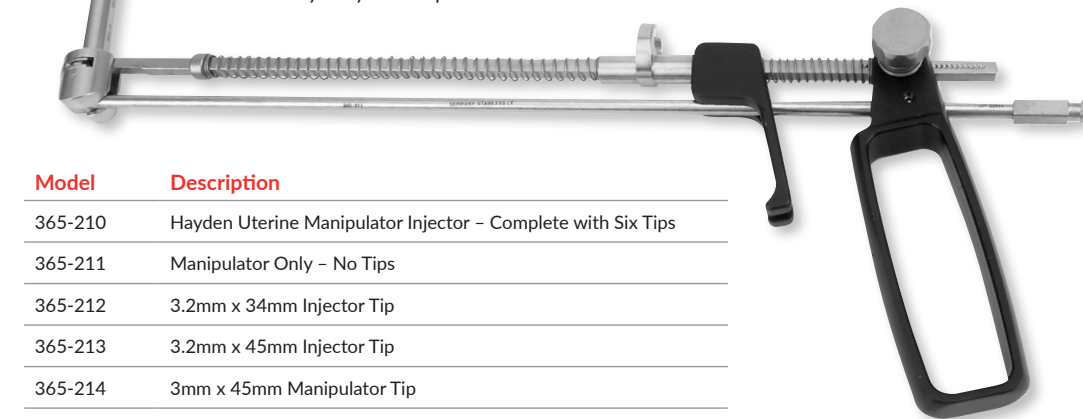

COHEN HAYDEN CANNULA / MANIPULATOR INJECTOR

Comes complete with one small and one large cervical cone.



Model	Description
★ 365-530	Cohen Hayden Cannula with Small & Large Acorn Tips
365-531	Small Acorn
365-534	Large Acorn

BARIATRIC SURGICAL INSTRUMENTS

Hayden Medical offers this comprehensive selection of longer instruments for use during abdominal deep pelvic procedures. Custom instruments are also available by request.

STERILIZATION CONTAINER & BASKET



Model	Description
R110.13	Container 22-7/8" L x 11" W x 5-1/4" H with Perforated Lid & Solid Bottom
R191.10	Wire Basket 21-5/8" L x 10-1/4" W x 4" H

ROCHESTER PEAN FORCEPS



Model	Size
140-130XL	14" Str.
140-130XXL	16" Str.
140-130XXXL	18" Str.
140-148XL	14" Cv.
140-148XXL	16" Cv.
140-148XXXL	18" Cv.

KOCHER FORCEPS



1x2 Teeth

Model	Size
140-158XL	14" Str.
140-158XXL	16" Str.
140-158XXXL	18" Str.
140-168XL	14" Cv.
140-168XXL	16" Cv.
140-168XXXL	18" Cv.

#3 SCALPEL HANDLE



Blade Sizes #10 - 15

Model	Size
040-407XL	14"
040-407XXL	16"
040-407XXXL	18"

CUSHING VEIN RETRACTOR



10mm Wide Jaw

Model	Size
105-311XL	14"
105-311XXL	16"
105-311XXXL	18"

YANKAUER SUCTION



Model	Size
190-610XL	14"
190-610XXL	16"
190-610XXXL	18"

ANDREWS SUCTION



2.5mm ID with Removable Tip

Model	Size
190-620P	14"
190-622P	16"
190-623P	18"

DEBAKEY FORCEPS



2.5mm Wide Tips

Model	Size
120-504XL	14"
120-504XXL	16"
120-504XXXL	18"

SINGLEY (TUTTLE) FORCEPS



Model	Size
120-216XL	14"
120-216XXL	16"
120-216XXXL	18"

RUSSIAN FORCEPS



Model	Size
120-146XL	14"
120-146XXL	16"
120-146XXXL	18"

DRESSING FORCEPS



Serrated Tips

Model	Size
120-018XL	14"
120-018XXL	16"
120-018XXXL	18"

TISSUE FORCEPS



1x2 Teeth

Model	Size
120-052XL	14"
120-052XXL	16"
120-052XXXL	18"

MD ANDERSON CLAMP



Model	Size
345-128XL	14"
345-128XXL	16"
345-128XXXL	18"

BARIATRIC SURGICAL INSTRUMENTS

Z-BEST™ HYSTERECTOMY CLAMPS



Model	Description
ZBCA-35	14" Straight
ZBCB-35	14" Slight Curve
ZBCC-35	14" Strong Curve
ZBCD-35	14" Angled
ZBCA-40	16" Straight
ZBCB-40	16" Slight Curve
ZBCC-40	16" Strong Curve
ZBCD-40	16" Angled

Z-BEST™ (MAYO) SERRATED SCISSORS



Tungsten Carbide

Model	Description
ZBSB-35	14" Slight Curve
ZBSB-40	16" Slight Curve
ZBSB-45	18" Slight Curve
ZBSC-35	14" Strong Curve
ZBSC-40	16" Strong Curve
ZBSC-45	18" Strong Curve
ZBSD-35	14" Jorgenson
ZBSD-40	16" Jorgenson
ZBSD-45	18" Jorgenson

METZENBAUM SCISSORS



Tungsten Carbide

Model	Description
500-193XL	14" Straight
500-193XXL	16" Straight
500-193XXXL	18" Straight
500-194XL	14" Curved
500-194XXL	16" Curved
500-194XXXL	18" Curved

FOERSTER (SPONGE) FORCEPS



Model	Size
140-601XL	14" Straight
140-601XXL	16" Straight
140-601XXXL	18" Straight
140-611XL	14" Curved
140-611XXL	16" Curved
140-611XXXL	18" Curved

SCHROEDER TENACULUM

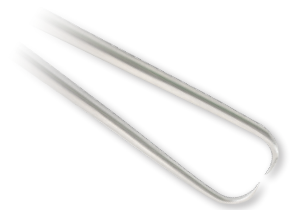

Model	Size
325-060XL	14"
325-060XXL	16"
325-060XXXL	18"

CLARK ARTERY FORCEPS



Side Curved

Model	Size
345-022XL	14"
345-022XXL	16"
345-022XXXL	18"

ALLIS FORCEPS



5x6 Teeth

Model	Size
140-814XL	14"
140-814XXL	16"
140-814XXXL	18"

BABCOCK FORCEPS

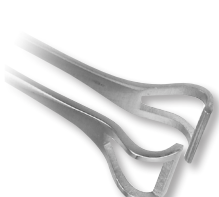

Model	Size
140-850XL	14"
140-850XXL	16"
140-850XXXL	18"

MIXTER FORCEPS



Fully Curved

Model	Size
140-210XL	14"
140-210XXL	16"
140-210XXXL	18"

GEMINI-MIXTER FORCEPS



Model	Size
140-260XL	14"
140-260XXL	16"
140-260XXXL	18"

HEANEY NEEDLE HOLDER



Tungsten Carbide

Model	Size
520-550XL	14"
520-550XXL	16"
520-550XXXL	18"

MASSON NEEDLE HOLDER



Tungsten Carbide

Model	Size
520-331XL	14"
520-331XXL	16"
520-331XXXL	18"

NOLAN NEEDLE HOLDER



Tungsten Carbide

Model	Description
520-870XL	14" Straight
520-870XXL	16" Straight
520-870XXXL	18" Straight
520-871XL	14" Curved
520-871XXL	16" Curved
520-871XXXL	18" Curved

PRATT XL UTERINE DILATORS



XL, 14" (35cm)		XXL 16" (40cm)	
Model	Size	Model	Size
290-313XL	13-15 Fr.	290-313XXL	13-15 Fr.
290-317XL	17-19 Fr.	290-317XXL	17-19 Fr.
290-321XL	21-23 Fr.	290-321XXL	21-23 Fr.
290-325XL	25-27 Fr.	290-325XXL	25-27 Fr.
290-329XL	29-31 Fr.	290-329XXL	29-31 Fr.
290-333XL	33-35 Fr.	290-333XXL	33-35 Fr.
290-337XL	37-39 Fr.	290-337XXL	37-39 Fr.
290-341XL	41-43 Fr.	290-341XXL	41-43 Fr.

OR | BARIATRIC SET

HAYDEN-TRAC™ TABLE FIXED RETRACTOR

This set has been the gold standard for many years. The comprehensive components of this set allow the surgeon many choices to make surgery safer and easier. Substitutions of set instruments are available.

HAYDEN-TRAC™ ABDOMINAL SET

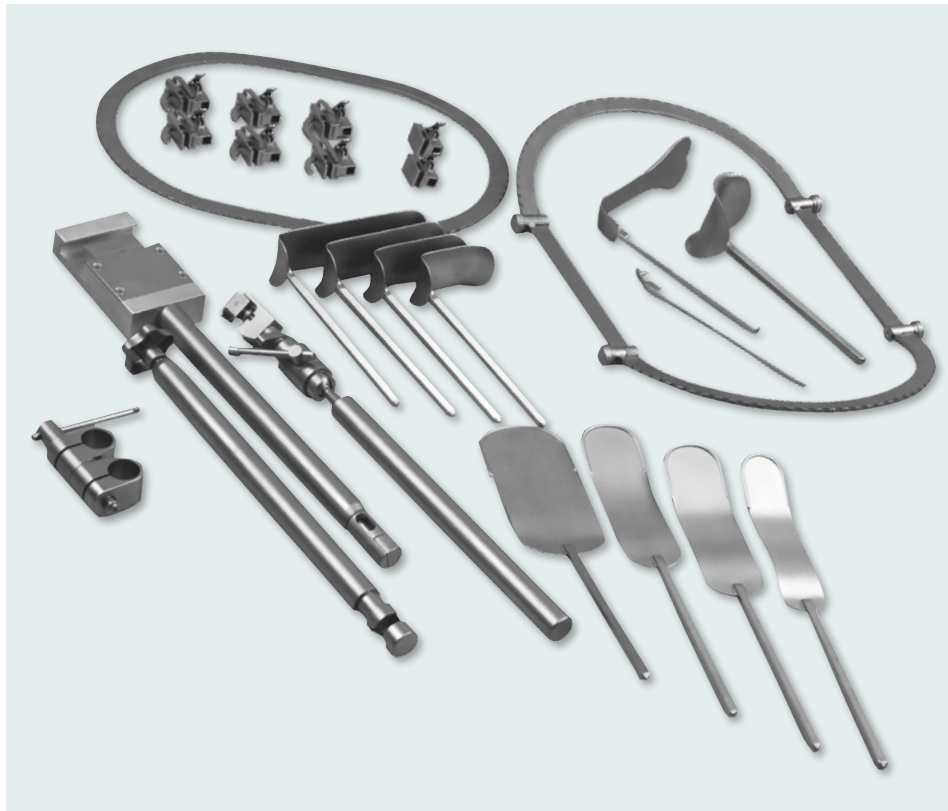

Model	Description
★ 108-002	Abdominal Set (Includes below)
108-101	Table Post
108-113	Horizontal Bar
108-114	1" Post Coupler
108-142	Medium Oval Ring
108-554	2" x 6" Malleable Retractor (2ea.)
108-366	2" x 3" Kelly Retractor (2 ea.)
108-368	2" x 4" Kelly Retractor
108-219	Balfour Retractor
108-127	Ratchet Mechanism (2ea.)
108-128	Tilt Ratchet Mechanism (6 ea.)
108-152	Medium Segmented Ring
108-534	1-1/2" x 6" Malleable Retractor
108-604	3" x 6" Malleable Retractor
108-370	2" x 5" Kelly Retractor
108-372	2" x 6" Kelly Retractor
108-112	Horizontal Flex Bar
108-260	2-1/2" x 5-5/8" Harrington Retractor
108-241	Gelpi Retractor

OR | HAYDEN-TRAC

TABLE MOUNTING COMPONENTS



Model	Description
108-101	Table Post, 18"
108-102	XL Table Post, 24"
108-111	Vertical Extension Bar, 1" x 12"
108-112	Horizontal Flex Bar
108-113	Horizontal Bar
108-114	1" Post Coupler

RETRACTOR RINGS

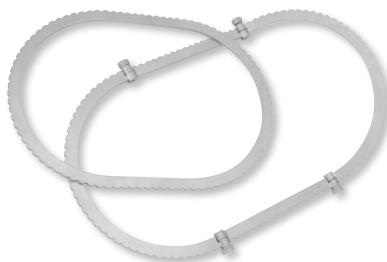

Model	Description
108-130	8-1/2" Round Ring, Small
108-132	10-1/2" Round Ring, Medium
108-134	12-1/2" Round Ring, Large
108-140	13-1/2" x 8-1/2" Oval Ring, Small
108-142	14-1/2" x 10-1/2" Oval Ring, Medium
108-144	18-1/2" x 12" Oval Ring, Large
108-150	8-1/2" x 14" Segmented Ring, Small
108-152	10-1/2" x 19-1/2" Segmented Ring, Med.
108-154	12-1/2" x 19-1/2" Segmented Ring, Large

HAYDEN-TRAC STERILIZATION TRAYS

These two sterilization containers are designed to hold the complete Hayden Trac Retractor Set. Diagrams help users correctly place and account for every component in the set.



108-196

Latching Lid

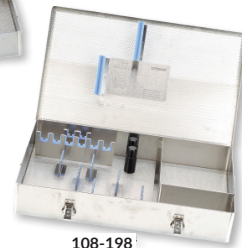

108-198

Model	Description
108-196	Table Fixation & Ring Case
108-198	Blades & Accessories Case

HAYDEN-TRAC™ TABLE FIXED RETRACTOR BLADES ACCESSORIES

Ask about additional Hayden Trac™ retractor blade and ring sizes, styles and components. Compare to Codman Bookwalter and save.

MALLEABLE BLADE WITH PROTECTIVE EDGE

The protective edge on our malleable blades minimizes tissue trauma and erosion by thickening the perimeter of the blade.

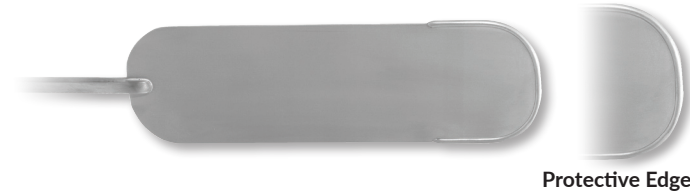

Protective Edge

Model	Description
108-511	1" x 4"
108-512	1" x 5"
108-514	1" x 6"
108-516	1" x 7"
108-518	1" x 8"
108-520	1" x 9"
108-530	1-1/2" x 4"
108-534	1-1/2" x 6"

Model	Description
108-554	2" x 6"
108-556	2" x 7"
108-560	2" x 9"
108-562	2" x 10"
108-566	2" x 12"
108-604	3" x 6"
108-606	3" x 7"
108-612	3" x 10"

KELLY BLADE



Model	Description
108-366	2" x 3"
108-368	2" x 4"
108-370	2" x 5"
108-372	2" x 6"
108-374	2" x 7"
108-376	2" x 8"
108-390	2-1/2" x 3"
108-398	2-1/2" x 7"
108-400	2-1/2" x 8"
108-404	2-1/2" x 10"
108-414	3" x 10"

BALFOUR BLADE



Model	Description
108-215	3-3/8" x 1-1/2"
108-219	3-3/8" x 2-3/4"
108-221	3-3/8" x 4"

RATCHET MECHANISM

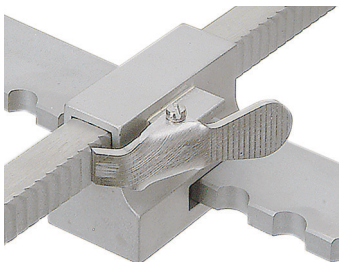

Model	Description
108-127	Fixed Ratchet Mechanism

TILT RATCHET MECHANISM

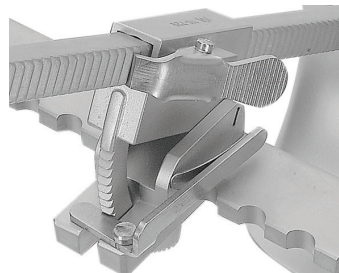

Model	Description
108-128	Tilt Ratchet Mechanism

HARRINGTON BLADE



Model	Description
108-257	2-1/2" x 9"
108-260	2-1/2" x 5-5/8"
108-268	3-1/2" x 10"

OR | HAYDEN-TRAC

UROLOGY RETRACTOR BLADES

YU-HOLTGREWE NOTCHED MALLEABLE RETRACTOR

Designed for optimal exposure of the dorsal vein complex and posterior retraction of the bladder during radical Retropubic Prostatectomy.



Model	Description
★108-840	2-1/2" x 7", with Ratchet Bar

CARROLL PROSTATIC RETRACTOR

Useful in Retropubic Radical Prostatectomy in a male with a wider pelvis.



Model	Description
108-842	1-1/2" Spreads to 3-1/2" x 7", with Ratchet Bar

HAYDEN-TRAC™ SETS

Complete Table-Mounted Retractor Sets from Hayden Medical offer comprehensive solutions for your operating room. Custom accessories can also be added if required by your surgeon.

HAYDEN-TRAC™ 24" BARIATRIC SET

This Hayden-Trac™ Bariatric Set is ideal for more obese patients. With an even taller 24" Field Post / Table Clamp it works as a complete stand alone system for the purpose of surgery on larger patients.

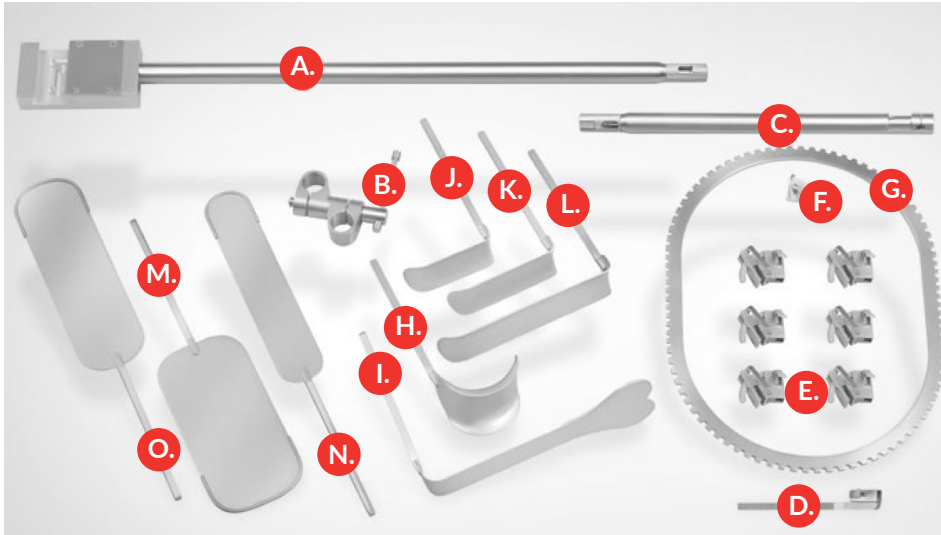

	Model	Description
	108-006	Bariatric Set (Includes below)
A.	108-102	Table Post 24"
B.	108-114	1" Post Coupler
C.	108-113	Horizontal Bar
D.	108-120	Ratchet Bar Extender
E.	108-128	Tilt Ratchet Mechanism (6 ea.)
F.	108-126	Twister Ratchet Adapter
G.	108-142	Medium Oval Ring
H.	108-219	Balfour Retractor 2-3/4" x 3-3/8"
I.	108-268	Harrington Retractor 3-1/2" x 10"
J.	108-366	Kelly Retractor 2" x 3" (2 ea.)
K.	108-368	Kelly Retractor 2" x 4"
L.	108-376	Kelly Retractor 2" x 8"
M.	108-632	Malleable Retractor 4" x 8"
N.	108-562	Malleable Retractor 2" x 10"
O.	108-612	Malleable Retractor 3" x 10"

HAYDEN-TRAC™ PEDIATRIC SET

The Hayden-Trac™ Pediatric Set can be used effectively on small size and younger patients with its smaller rings and blades to match specific needs. It is useful for almost all general surgeries such as abdominal aortic aneurysms, hysterectomies, appendectomies, hernia repairs, iliac femoral grafts, nephrectomies, retroperitoneal resections, and transplants.

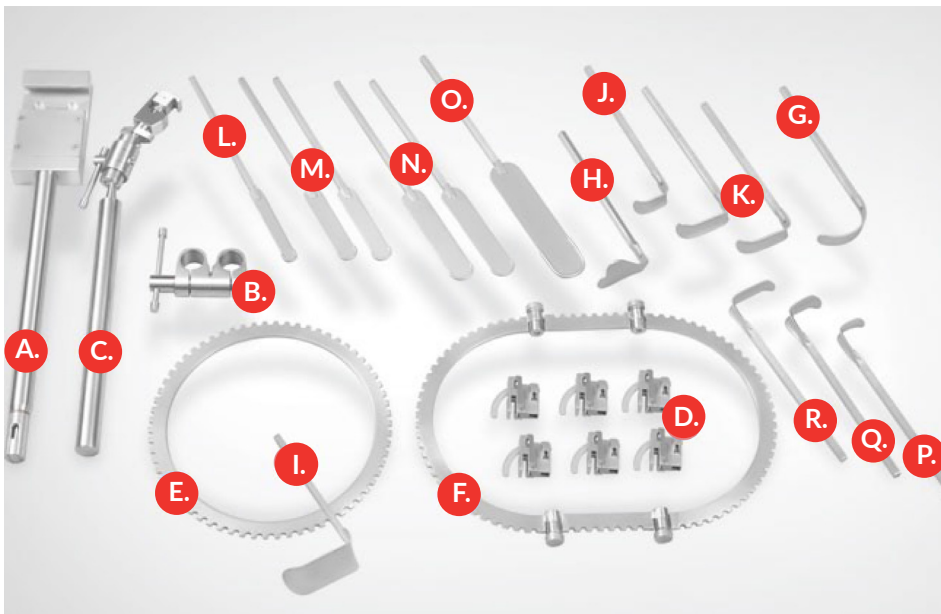

	Model	Description
	108-005	Pediatric Set (Includes below)
A.	108-101	Table Post 12"
B.	108-114	1" Post Coupler
C.	108-112	Horizontal Flex Bar
D.	108-128	Tilt Ratchet Mechanism (6 ea.)
E.	108-130	Small Round Ring
F.	108-150	Small Segmented Ring
G.	108-737	Deaver Retractor Blade 2/3" x 2-1/4"
H.	108-249	Harrington Retractor 2" x 2-1/2"
I.	108-361	Kelly Retractor 2" x 1-1/2"
J.	108-322	Kelly Retractor 1" x 2-1/2"
K.	108-321	Kelly Retractor 1" x 3" (2 ea.)
L.	108-500	Malleable Retractor 1/2" x 4"
M.	108-510	Malleable Retractor 3/4" x 4" (2 ea.)
N.	108-512	Malleable Retractor 1" x 5" (2 ea.)
O.	108-554	Malleable Retractor 2" x 6"
P.	108-720	Richardson Retractor 3/4" x 1"
Q.	108-724	Richardson Retractor 1" x 1-1/4"
R.	108-722	Richardson Retractor 3/4" x 2"

OR | HAYDEN-TRAC SETS

HAYDEN-TRAC™ SETS

HAYDEN-TRAC™ VAGINAL SET

The Hayden-Trac™ Vaginal Set has been a popular kit for gynecology. It features an egg shaped fixed ring with 20° angle for proper positioning. Depending upon the procedures the 5 suggested blades provide maximum exposure of the surgical site.

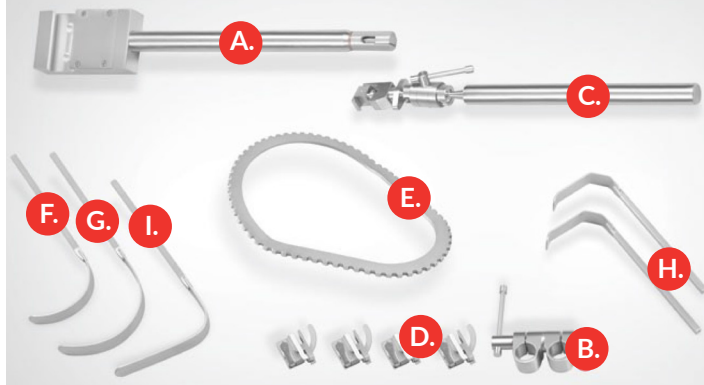

Model	Description
★ 108-009	Vaginal Set (Includes below)
A.	108-101 Table Post 12"
B.	108-114 1" Post Coupler
C.	108-112 Horizontal Flex Bar
D.	108-128 Tilt Ratchet Mechanism (4 ea.)
E.	108-183 Vaginal Offset Retractor Ring 8" x 10-1/2"
F.	108-740 Deaver Retractor Blade 1" x 3-1/2"
G.	108-744 Deaver Retractor Blade 1" x 5"
H.	108-420 Magrina Style Lateral Vaginal Retractor 1" x 3" (2 ea.)
I.	108-421 Magrina Style Lateral Vaginal Retractor 1" x 4-1/2"

HAYDEN-TRAC™ UROLOGY SET

The Hayden-Trac™ Urology Set is customized for abdominal and or perineal approaches to the bladder, kidneys, ureters and other organs. A variety of 12 blades offer suitable exposure opportunities. 2 segmented rings permit 8 ring size configurations and virtually unlimited ring angles, for different shapes and sizes of patients.

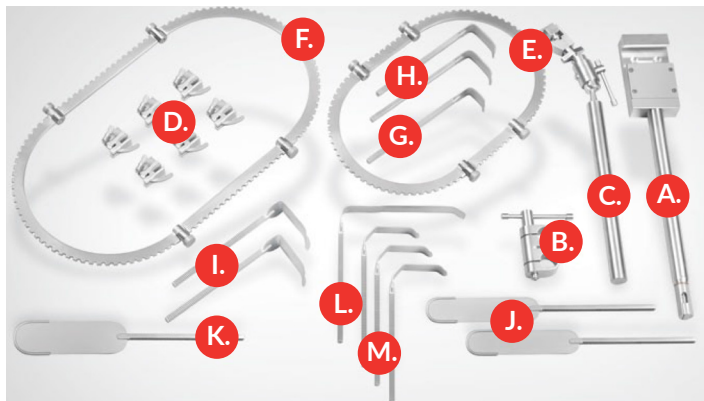

Model	Description
108-008	Urology Set (Includes below)
A.	108-101 Table Post 12"
B.	108-114 1" Post Coupler
C.	108-112 Horizontal Flex Bar
D.	108-128 Tilt Ratchet Mechanism (8 ea.)
E.	108-150 Small Segmented Oval Ring
F.	108-152 Medium Segmented Oval Ring
G.	108-320 Kelly Retractor 1" x 1-1/2"
H.	108-322 Kelly Retractor 1" x 2-1/2" (2 ea.)
I.	108-364 Kelly Retractor 2" x 2-1/2" (2 ea.)
J.	108-534 Malleable Retractor 1/2" x 6" (2 ea.)
K.	108-554 Malleable Retractor 2" x 6"
L.	108-449 Wylie Renal Vein Retractor 1" x 7"
M.	108-420 Magrina Style Vaginal Retractor 1" x 3" (3 ea.)



HAYDEN-TRAC™ RECTAL SET

The Hayden-Trac™ Rectal Set is a complementary add on to meet the essential requirements for rectal/trans-anal procedures. Small round ring allows convenient adjustment and repositioning of retractor blades. Small and large blades offer choices for different patients or procedures.

Model	Description
108-007	Rectal Set (Includes below)
A.	108-130 Small Round Ring
B.	108-710 Rectal Retractor 7/8" x 2-7/8" (2 ea.)
C.	108-712 Rectal Retractor 7/8" x 3-7/8" (2 ea.)

LAPAROSCOPIC NEEDLE HOLDERS

The ergonomic ratchet handles and tungsten carbide jaws make these 5mm diameter needle holders well balanced and reliable. The strong jaws hold the needle firmly in place, even at the tip of the jaw.

AXIAL HANDLE

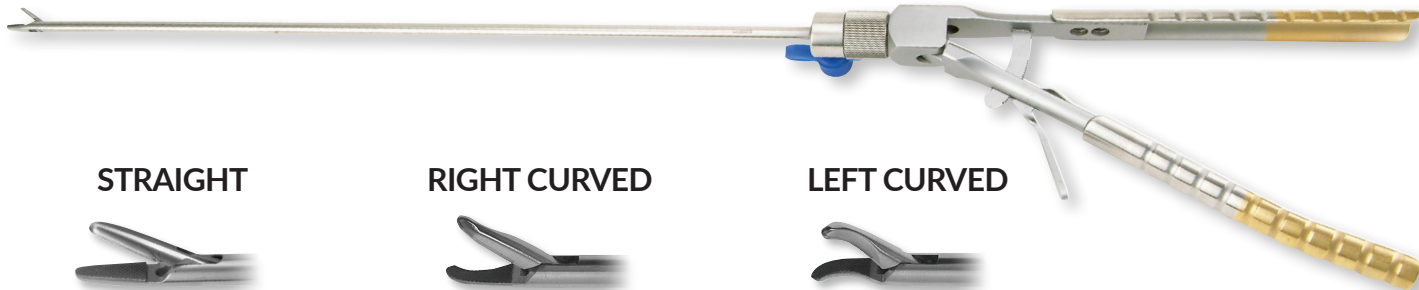

STRAIGHT



RIGHT CURVED



LEFT CURVED



Model	Description
★ HE13-1592	10mm Long Jaw, 33cm
HE13-1592-45	10mm Long Jaw, 45cm

Model	Description
HE13-1593	33cm
HE13-1593-45	45cm

Model	Description
HE13-1594	33cm
HE13-1594-45	45cm

PISTOL GRIP



STRAIGHT



RIGHT CURVED

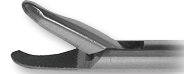

LEFT CURVED



ROMEO SELF-UPRIGHTING



Model	Description
HE13-1591P	33cm
HE13-1591P-45	45cm

Model	Description
HE13-1593P	33cm
HE13-1593P-45	45cm

Model	Description
HE13-1594P	33cm
HE13-1594P-45	45cm

Model	Description
HE13-1590PSFU	33cm
HE13-1590PSFU-45	45cm

ETH



STRAIGHT



RIGHT CURVED

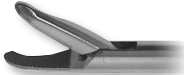

LEFT CURVED



ROMEO SELF-UPRIGHTING



Model	Description
HE13-1591ET	33cm
HE13-1591ET-45	45cm

Model	Description
HE13-1593ET	33cm
HE13-1593ET-45	45cm

Model	Description
HE13-1594ET	33cm
HE13-1594ET-45	45cm

Model	Description
HE13-1590ETSFU	33cm
HE13-1590ETSFU-45	45cm

OR | LAP NEEDLE HOLDERS

HASSON GRASPERS

Laparoscopic instrument for retraction of myomas, fibroids, ovaries & other organs.

HASSON 3 PRONG GRASPER

5mm Diameter

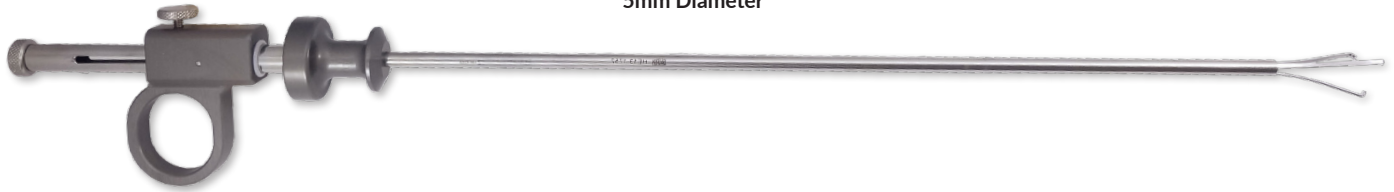

AGGRESSIVE JAWS



CURVED ALLIS TEETH



STRAIGHT ALLIS TEETH



BLUNT EDGED JAWS



Model	Description
HE13-1752	32cm
HE13-1752-45	45cm

Model	Description
HE13-1753	32cm
HE13-1753-45	45cm

Model	Description
HE13-1754	32cm
HE13-1754-45	45cm

Model	Description
HE13-1755	32cm
HE13-1755-45	45cm

SOVEREIGN & PRESTIGE STYLE GRASPERS

SLIDE RACHET HANDLE GRASPERS



ATRAUMATIC GRASPER

Retraction forceps with wavy atraumatic inner jaws.



Model	Description
HE13-1381DG	5mm Non-Rotating, 33cm
★ HE13-1381ADG	5mm Rotating, 33cm
HE13-1381DG-45	5mm Non-Rotating, 45cm
HE13-1381ADG-45	5mm Rotating, 45cm

RETRACTION GRASPER

Retraction forceps with atraumatic inner teeth.



Model	Description
HE13-1380DG	5mm Non-Rotating, 33cm
★ HE13-1380ADG	5mm Rotating, 33cm
HE13-1380DG-45	5mm Non-Rotating, 45cm
HE13-1380ADG-45	5mm Rotating, 45cm

Double action jaws also available.

OR | HASSON GRASPERS

LAPAROSCOPIC RETRACTORS

KITE RETRACTOR

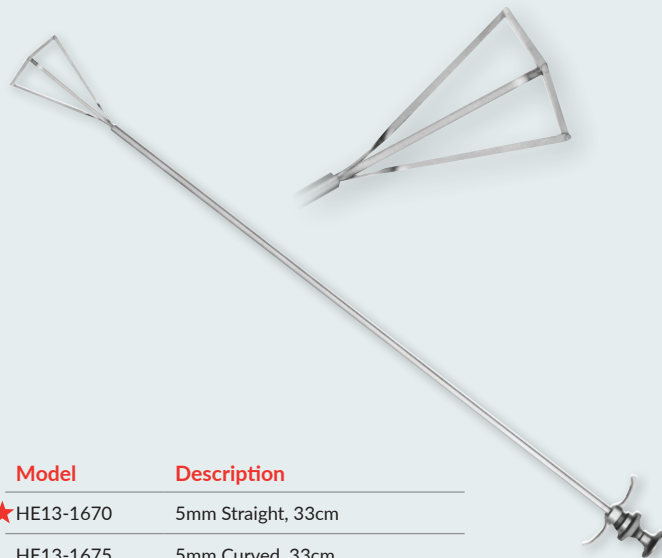

Model	Description
★ HE13-1670	5mm Straight, 33cm
HE13-1675	5mm Curved, 33cm
HE13-1677	5mm Angled, 33cm
HE13-1670-45	5mm Straight, 45cm
HE13-1675-45	5mm Curved, 45cm

FAN RETRACTOR

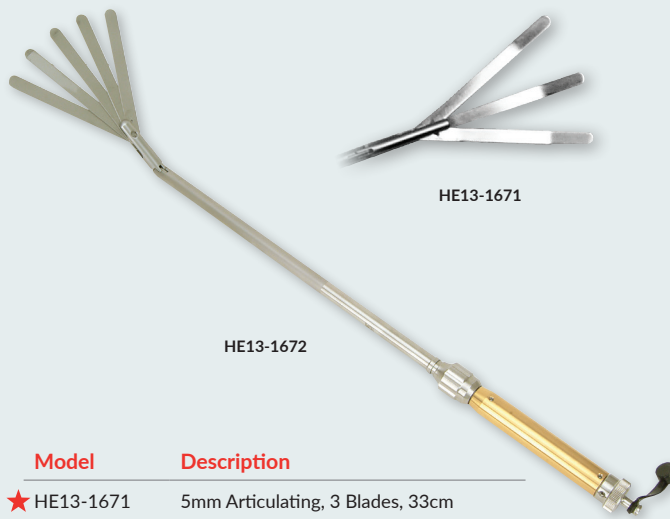

Model	Description
★ HE13-1671	5mm Articulating, 3 Blades, 33cm
★ HE13-1672	10mm Articulating, 5 Blades, 33cm
HE13-1673	5mm Non-Articulating, 3 Blades, 33cm
HE13-1674	10mm Non-Articulating, 5 Blades, 33cm
HE13-1671-45	5mm Articulating, 3 Blades, 45cm
HE13-1672-45	10mm Articulating, 5 Blades, 45cm

KNOT PUSHERS

OPEN END



Model	Description
★ HE13-16170	33cm
★ HE13-16170-45	45cm

CLOSED END



Model	Description
★ HE13-1617C	33cm
★ HE13-1617C-45	45cm

SLOTTED



Model	Description
HE13-1617SL	33cm
HE13-1617SL-45	45cm

BLACK HANDLE LAPAROSCOPIC KNOT PUSHERS



OPEN END



Model	Description
★ HE13-1616O	32cm
★ HE13-1616O-45	45cm

CLOSED END



Model	Description
HE13-1616C	32cm
HE13-1616C-45	45cm

LAPAROSCOPY ACCESSORIES

TACTILE PROBES

Graduated in cm's



Model	Description
HE10-1110	33cm, 5mm
HE10-1110-45	45cm, 5mm

MYOMA SCREW



Model	Description
HE10-1096	5mm, 33cm
HE10-1097	10mm, 33cm

INJECTION / ASPIRATION NEEDLE

5mm with Luer Connection

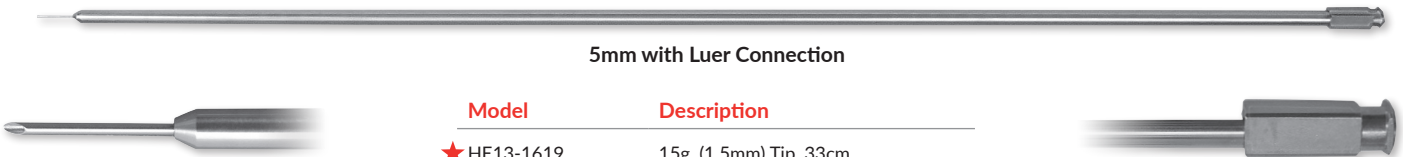

Model	Description
★ HE13-1619	15g. (1.5mm) Tip, 33cm
HE13-1619-45	15g. (1.5mm) Tip, 45cm

SUCTION / IRRIGATION TUBE

5mm with Stopcock



Model	Description
HE11-1270	33cm
HE11-1270-45	45cm









S-RETRACTORS



Model	Description
HE10-1098A	1/4" Wide, Pair
★ HE10-1098B	3/8" Wide, Pair
HE10-1098C	1/2" Wide, Pair

LAPAROSCOPIC MONOPOLAR HIGH FREQUENCY ELECTRODES



	Model 33cm	Model 45cm	Description
	HE11-1170	HE11-1170-45	Spatula Tip
	★ HE11-1175	HE11-1175-45	L-Hook Tip
	HE11-1180	HE11-1180-45	Knife Tip
	★ HE11-1185	HE11-1185-45	J-Hook Tip
	HE11-1188	HE11-1188-45	Sickle Tip
	HE11-1195	HE11-1195-45	Needle Tip
	HE11-1205	HE11-1205-45	Cone Tip
	HE11-1210	HE11-1210-45	Button Tip

LAPAROSCOPIC MONOPOLAR HIGH FREQUENCY CABLE



Autoclavable

Model	Description
HE11-1261	5mm Plug, 10'
★ HE11-1262	8mm Plug, 10'

HE11-1262

LAPAROSCOPIC FASCIA CLOSURE SET

FASCIA CLOSURE SUTURE RETRIEVER

- Laparoscopic Trocar incision wound closure & hernia suture retriever
- Precision micro-pointed & polished tip with platform
- Cleaning flush port



Model	Description
HE10-1114	3mm Dia., 17cm
HE10-1115	3mm Dia., 20cm

TROCAR GUIDE CONES

Stainless Steel

6cm Length

Model	Description
HE10-5012	5mm Diameter
HE10-5013	10/11mm Diameter
HE10-5014	12mm Diameter
HE10-5015	15mm Diameter

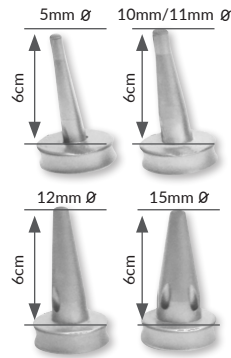

Stainless Steel

10cm Length

Model	Description
HE10-5016	5mm Diameter
HE10-5017	10/11mm Diameter
HE10-5018	12mm Diameter
HE10-5019	15mm Diameter

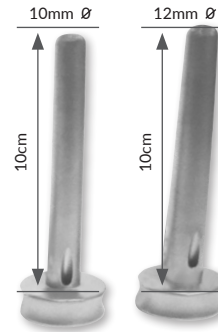

STERILIZATION CONTAINERS AND BASKETS

STERILIZATION CASES



- Available in different lid colors silver, yellow, red, blue and green
- Available in perforated & non-perforated lids or bases
- More container heights available

Half Size

Model	Description
R310.10	Sterilization Container, Perforated Lid & Solid Bottom, 11-1/2"L x 11"W x 4"H (285 x 280 x 100mm), Silver Lid
R390.07	Wire Basket, 10-1/4"L x 9-7/8"W x 2-3/4"H (255 x 245 x 70mm) with Inside Handles
R310.13	Sterilization Container, Perforated Lid & Solid Bottom, 11-1/2"L x 11"W x 5-1/3"H (285 x 280 x 135mm), Silver Lid
R390.10	Wire Basket, 10-1/4"L x 9-7/8"W x 4"H (255 x 245 x 100mm) with Inside Handles

Medium Size

Model	Description
R210.10	Sterilization Container, Perforated Lid & Solid Bottom, 18-3/8"L x 11"W x 4"H (465 x 280 x 100mm), Silver Lid
R290.07	Wire Basket, 16-3/8"L x 10-1/4"W x 2-3/4"H (405 x 255 x 70mm), with Inside Handles
R210.13	Sterilization Container, Perforated Lid & Solid Bottom, 18-3/8"L x 11"W x 5-1/3"H (465 x 280 x 135mm), Silver Lid
R290.10	Wire Basket, 16-3/8"L x 10-1/4"W x 4"H (405 x 255 x 100mm), with Inside Handles

Full Size

Model	Description
R110.10	Sterilization Container, Perforated Lid & Solid Bottom, 22-7/8"L x 11"W x 4"H (580 x 280 x 100mm), Silver Lid
R191.07	Wire Basket, 21-5/8"L x 10-1/4"W x 2-3/4"H (540 x 255 x 70mm) with Inside Handles
R110.13	Sterilization Container, Perforated Lid & Solid bottom, 22-7/8"L x 11"W x 5-1/3"H (580 x 280 x 135mm), Silver Lid
R191.10	Wire Basket, 21-5/8"L x 10-1/4"W x 4"H (540 x 255 x 100mm) with Inside Handles

ENDOSCOPES

Hayden Medical endoscopes offer brilliant clear optics. Our scopes are high quality and autoclavable.

LAPAROSCOPES

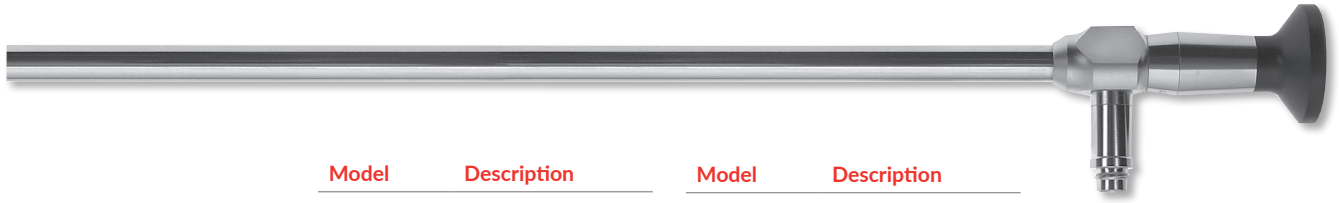

Model	Description	Model	Description
HE11-1120	5mm, 0°, 305mm	HE11-1130	10mm, 0°, 315mm
HE11-1125	5mm, 30°, 305mm	HE11-1135	10mm, 30°, 315mm
HE11-1126	5mm, 45°, 305mm	HE11-1136	10mm, 45°, 315mm



HYSTEROSCOPES

Model	Description
HE18-2340	4mm, 0°
HE18-2342	4mm, 15°
HE13-2341	4mm, 30°
HE18-2343	4mm, 70°

Model	Description
HE18-2344	2.7mm, 0°
HE18-2346	2.7mm, 30°
HE18-2347	2.7mm, 70°

CYSTOSCOPE - RESECTOSCOPE

Model	Description
HE32-4000	4mm, 0°
HE32-4010	4mm, 15°
HE32-4020	4mm, 30°
HE32-4030	4mm, 70°

Model	Description
HE32-4005	2.7mm, 0°
HE32-4015	2.7mm, 15°
HE32-4025	2.7mm, 30°
HE32-4035	2.7mm, 70°

ARTHROSCOPES

Model	Description
HE17-1750	4mm, 0°, 175mm
HE17-1755	4mm, 30°, 175mm
HE17-1760	4mm, 70°, 175mm
HE17-1751	2.7mm, 0°, 187.5mm
HE17-1756	2.7mm, 30°, 187.5mm
HE17-1761	2.7mm, 70°, 187.5mm
HE17-1752	2.7mm, 0°, 110mm
HE17-1757	2.7mm, 30°, 110mm
HE17-1762	2.7mm, 70°, 110mm



FIBER-OPTIC LIGHT CABLES



INDEX

4-Way Expander Specula	16	F		LLETZ Accessories	30-31	Silicone Pessary Fitting Sets	26
A		Fan Retractors	60	LLETZ Instruments	34	Sims Dilator Sound	18
Acorn Tips	51	Fascia Closure Set	62	LLETZ Lateral Wall Retractors	33	Sims Uterine Curette	8
Adapter, Electrosurgical Unit	30	Fascia Harvester	46	LLETZ Specula	32-33	Singley (Tuttle) Forceps	46, 52
Adson Forceps	12	Fiber-optic Cables	43	Loop Electrodes	29	Slide Ratchet Handle Grasper	59
Adson Brown Forceps	12	Fiber-optic Retractors	43	M		Smoke Evacuator	28
Allis Forceps	10, 35	Filters, Smoke Evacuator	30-31	Malleable Retractors	55	Smoke Evacuator Accessories	30-31
Arthroscopes	63	Fixed Ratchet Mechanism	55	Mallet	42	Smoke Evacuator Filters	30-31
Aspiration Needle	61	Foerster Sponge Forceps	10, 34-35	Martin's Arm Retractors	48-49	Smoke Evacuator Tubing	30-31
Atraumatic Grasper	59	G		Masson Needle Holder	53	Smoke Tubing Reducer	31
Atraumatic Tenaculum	10	Gehrung Pessary	25	Mayo Scissors	13	Snake Retractors	50
Auvard Weighted Specula	47	Gellhorn Pessary	24	Mayo-Hegar Needle Holder	11, 13	Sopher Ovum Forceps	17
B		Gellhorn Pessary Fitting Set	26	McCall Uterosacral Clamp	47	Sounds	18
Baby Tischler Biopsy	4, 6-7	Gomco Circumcision Clamp	21	McCrea Urethral Sounds	20	Specula, Stainless	14-16
Ball Electrode	29	Graves Specula	14-16	MD Anderson Clamps	46, 52	Specula, Laser	35
Bariatric Instruments	52-53	H		Metzenbaum Scissors	11, 13	Specula, LLETZ	32-33
Bierer Ovum Forceps	17	Hank Dilators	19	Miyazaki All-Purpose Retractor	42	Sponge Forceps, Laser	35
Biopsy Punch Forceps	4-7	Hardy-Duddy Speculum	47	Miyazaki Hook	42	Sponge Forceps, LLETZ	34
Bonney Forceps	12	Hasson Graspers	59	Miyazaki Sacropepy Retractor	42	Sponge Forceps, Stainless	10, 34-35
Bozeman-Heaney Needle Holder	46	Hawkin-Amblor Dilators	20	Miyazaki Tack Driver	42	Steiner Weighted Speculum	47
Bozeman Uterine Forceps	10	Hayden-Trac Retractor	54-57	Monsel's Paste	30	Sterilization Basket	48, 62
Braun Tenaculum	10, 34-35	Hayden Uterine Manipulator	51	Myoma Forceps	17	Sterilization Containers	52, 62
Breisky Harrington Retractor	43	Heaney Needle Holder	13	Myoma Screw	61	Sterilization Trays	62
Breisky Navratil Retractor	42, 47	Heaney-Simon Retractor	43	N		Stools	41
Breisky Vaginal Retractors	47	Hegar Dilators	19	Needle, Aspiration	61	St. Mark's Retractor	43
Burke Biopsy Punch	4, 6	Hemorrhage Occluder Pin	42	Needle Extenders	34	Syringe, Dental	30
C		Hodge Pessary	25	Needle Holders	11, 13	T	
Carrol Prostatic Retractor	55	Holds Fascia Harvester	46	Nolan TC Needle Holder	45	Table Clamps	49
Catheters, HSG	22	Hooks, Laser	35	No-Scalpel Vasectomy	21	Table Mounting Components	54
Catheters, Walther	20	Hooks, LLETZ	34	Non-conductive Instruments	30-34	Tactile Probe	61
Cervical Biopsy Forceps	4-7	Hooks, Stainless	9	Novak Endometrial Curette	8	Tenacula, Stainless Steel	10
Cervical Dilators	18-19, 53	HSG Procedure Kit	23	Noyes Grasper	11	Tenacula, Laser	35
Cervical Hooks	9, 34-35	HSG Sono Catheters	21	O		Tenacula, LLETZ	34
Cervical Tenacula	10, 34-35	Hulka Uterine Tenacula	47	Operating Scissors	13	Tenaculum Forceps	10, 34-35
Circumcision Clamps	21	Hysterectomy Clamps	44	Os Cervical Dilator Set	18	Tilt Ratchet Mechanism	55
Clark Artery Forceps	46, 53	Hysterectomy Scissors	45	Oval Pessary	24	Tischler Biopsy Forceps	4, 6-7
Cohen Uterine Manipulator	51	Hysteroscopy Graspers	40	Oval Pessary Fitting Set	26	Tissue Forceps	12, 34-35
Colposcopes	37	Hysteroscopy Scopes	40, 63	Ovum Forceps	17	Tissue Forceps, Laser	35
Corson Myoma Grasper	17	Hysteroscopy Sheaths	40	P		Tissue Forceps, Non-Conductive	34
Crile-wood Needle Holder	13	I		Pederson Specula	14-16	Tubing, Smoke Evacuator	30-31
Cryosurgery	38-39	Incontinence Dish Pessary	24	Pelvic Exam Sticks	27	U	
Cube Pessary	25	Incontinence Ring Pessary	25	Pelvic Surgery Instruments	44-49	Urethral Dilators, McCrea	20
Cube Pessary Fitting Set	26	Inflatable Pessary	26	Pencils, Electrosurgical	30-31	Urethral Sounds, Dittel	21
Curettes, Endometrial	8	Insemination Catheter	23	Pessaries, Silicone	24-26	Urethral Sounds, Van Buren	21
Curettes, Uterine	8	Iris Hook	9, 34-35	POP-Q Stix	27	Urethral Sounds, Walther	20
Curette with Syringe	8	Iris Scissors	13	Potts-Smith Forceps	12, 34	Urology	20-21
Cystoscopes	63	IUD Hooks	11	Pratt Dilators	19, 53	Urology Retractor Blades	57
D		IUD Instruments	11	Preferred Curette	8	Uterine Curettes	8
Deaver (Deep) Retractor	43	IUD Scissors	11	Prestige Grasper	59	Uterine Dilators	18-20
DeBakey Forceps	52	IUI Catheter	23	Probes, Laparoscopic	61	Uterine Forceps	10
Denniston Dilator Set	19	J		Q		Uterine Manipulator / Injectors	22, 51
Dental Syringe	30	Jackson Style Biopsy Forceps	5	Quick-Connect Retractor	49	Uterine Sounds	18
Dilators, Silicone	26	Jewett Sounds	20	R		Uterine Tenacula	10, 47
Dilators, Stainless	18-21	K		Rainbow Cervical Biopsy	7	V	
Dish Pessary	24	Kelly Retractor Blades	55-57	Rainbow Endocervical Curettes	7	Vaginal Dilator Sets	26
Dish Pessary Fitting Set	26	Kevorkian Biopsy Punch	4, 6	Randall Cervical Forceps	10	Van Buren Urethral Sounds	21
Disposable Biopsy Punches	17	Kevorkian Endocervical Curette	7, 8	Ratchet Mechanisms	55	Vasectomy (No-Scalpel)	21
Disposable Endometrial Samplers	8	Kite Retractors	60	Reducer, Smoke Tubing	31	W	
Disposable Os Dilators	18	Kleegman Dilator	18	Retraction Forceps	59	Walther Dilators / Catheters	20
Disposable Uterine Manipulators	51	Knot Pushers	60	Retractor Rings	54-57	Wavy Atraumatic Grasper	59
Dittel Urethral Sounds	21	Kogan Endocervical Specula	9, 34-35	Retractors	54-57	Weighted Specula	47
Donut Pessary	25	Krobach Tissue Clamp	45	Returned Goods Policy	2	Weisman Open-side Specula	16
Dopplers	36	L		Ring Forceps (Foerster)	10, 34-35	Wittner Biopsy Punch	5
Dressing Forceps	12, 34-35	Laparoscopes	63	Ring Pessary	24	Word Bartholin Catheter Set	26
Dressing Forceps, Laser	35	Laparoscopic Fan Retractors	60	Ring Pessary Fitting Set	26	Wylie Retractor	43
Dressing Forceps, LLETZ	34	Laparoscopic Fascia Closure Set	62	Rotating Biopsy Punch	5	Y	
E		Laparoscopic Graspers	59	Russian Forceps	46, 52	Yankauer Suction Tube	43
Electrode Pads	30-31	Laparoscopic Kite Retractors	60	S		Yu-Holtgrewe Retractor	55
Electrode Tip Cleaner	29	Laparoscopic Knot Pushers	60	S-Retractors	61	Z	
Electrodes	29	Laparoscopic Needle Holders	58	Sacral Tack	42	Z-Best Hysterectomy Clamps	44, 53
Electrosurgery	30-34	Laparoscopic Tactile Probe	61	Schroeder Tenaculum	10, 34-35	Z-Best (Mayo) Scissors	45, 53
Electrosurgical Pencils	30-31	Laparoscopic Uterine Manipulator	51	Scissors	13, 53	Z-Best Parametrium Scissors	45, 53
Electrosurgical Unit	28	Laser Instruments	35	Scissors, Hysterectomy	45, 53		
Electrosurgical Unit Adapter	30	Lateral Wall Retractors, LLETZ	33	Scope Holder Attachment	48-49		
Emmett Hooks	9, 34-35	Lateral Wall Retractors, Stainless	16	Serpentine IUD Grasper	11		
Endocervical Curette	7-8	Light Cables	43	Shaatz Pessary	24		
Endocervical Specula, Laser	35	Lighted Retractors	43	Silicone Dilator Sets	26		
Endocervical Specula, LLETZ	34	Liver Retractors	49	Silicone Pessary	24-26		
Endocervical Specula, Stainless	9	LLETZ (electrosurgery)	28-34				
Endometrial Curettes	8						
Eppendorfer	5-6						